



Galbusera

Ferro battuto d'arte = Traditional Ironwork



CATALOGO FERRAMENTA ARTISTICA 2014
ARCHITECTURAL HARDWARE CATALOGUE 2014

DAL 1925 – SINCE 1925
MADE IN ITALY



Galbusera Giancarlo & Giorgio snc

Premiata fabbrica ferro battuto d'arte = ferramenta artistica

SEDE – HEAD OFFICE

23868 VALMADRERA (LC) – ITALY

VIA G. VERDI 10

T: +39 (0)341 58.12.84 F: +39 (0)341 20.10.68

E: MAIL@GALBUSERAGG.IT

W: WWW.GALBUSERAGG.IT

WWW.ANTIKBESCHLAEGE.BIZ

PARTITA IVA E CODICE FISCALE: IT 00205480130

PRODUZIONE-PRODUCTION

23868 VALMADRERA (LC) VIA G. VERDI 10

23862 CIVATE (LC) VIA SAN PAOLO 1

FONDATA NEL 1925

SINCE 1925



Premio Qualità
Quality Award



Albo d'oro del Lavoro
Business Gold Award



Galbusera produce:

Ferro Battuto D'Arte

Servizi ed attrezzi per camino, alari, parascintille, portalegna, catena per camino e griglie per camino. Spiedi girarrosti per esterni ed interni. Campane per ingressi, banderuole segnamento, cassette per lettere a muro, a piantana. Portabottiglie, cavatappi, portariviste, portachiavi, portacenere, oggetti decorativi, candelieri, articoli da regalo. Specchiere e consolle, attaccapanni, portabiti, portaombrelli, fioriere. Illuminazione: lampadari, appliques, lampade, abatjourns, lampioni, lanterne a braccio e a catena. Riloghe e scorritende.

Ferramenta artistica in ferro forgiato e battuto

Maniglie per porte, martelline e cremonesi per finestre, cerniere, paumelles per porte e finestre, maniglioni, battenti, pomoli, chiavistelli, catenacci, spranghe, bandelle, squadre, spagnolette, fermapersiane, chiodi, borchie copridado, teste per chiavi, coprinterruttori, targhe e buche per lettere con campanello, mensole piane a gancio, ganci universali e appendiabiti, catene. Manigliette, cerniere, pomoli, pendenti, bocchette, decorazioni per guarnizioni mobili. Riloghe e accessori scorritenda, piastre copriavvolgibili, reggicordoni. Pannelli, elementi, particolari, foglie, aste, barre in ferro grezzo per lavorazioni artistiche.

Arredi da giardino per esterni in ferro battuto

Fioriere, portafiori, lanterne e lampade a stelo, a muro e a catena, in stile "Liberty floreale".



The Company Galbusera manufactures:

Artistic wrought-iron

Fireplace sets and accessories: andirons, fire screens, wood holders, fireplace chain. Roasting jacks for home and garden. Doorbells, weathervanes, wall - and floor - letter boxes. Bottle-racks, magazine-racks, corkscrews, key boxes, ashtrays, ornamental items, candlesticks, giftware. Mirrors and consoles, clothes stands and clothes hooks, umbrella stands, flower boxes. Lighting fixtures: chandeliers, sconces, lamps, abatjourns, wall lanterns, chain hung lanterns. Curtain rails and rods.

Fine forged and wrought-iron hardware

Door and window handles and cremona bolts, hinges for doors and windows, door knockers, knobs, bar latches, barrel bolts, bars, strap hinges, flat corner irons, espagnolettes, shutter stops and holders, nails, escutcheon plates, style key heads, switch plates, letter plates and boxes, doorbells, hook brackets, standard brackets, hat & coat hooks and chains.

Handles, hinges, knobs, pendant pulls, plates, furniture decorations. Curtain rails and accessories, roller shutter covers, rope brackets. Panels, elements, leaves, rods, iron bars for fine forged and wrought iron workings.

Wrought-iron furniture and fittings for the garden

Flower boxes, flower stands, floor lamps, wall lamps, chain hung lamps and lanterns in "Liberty style"

INDICE - INDEX:

Maniglie per porte e finestre / Door and window handles collections :

Collezione "Roma" / "Rome" collection	Pagina / Page 4-5
Collezione "Londra" / "London" collection	Pagina / Page 6-7
Collezione "Oslo" / "Oslo" collection	Pagina / Page 8-9
Collezione "Berlino" / "Berlin" collection	Pagina / Page 10-11
Collezione "Madrid" / "Madrid" collection	Pagina / Page 12-13
Collezione "Lisbona" / "Lisbon" collection	Pagina / Page 14-15
Collezione "Berna" / "Bern" collection	Pagina / Page 16-17
Collezione "Mosca" / "Moscow" collection	Pagina / Page 18-19
Collezione "Budapest" / "Budapest" collection	Pagina / Page 20-21
Collezione "Tallin" / "Tallin" collection	Pagina / Page 22-23
Collezione "Monaco" / "Munich" collection	Pagina / Page 24
Collezione "Brema" / "Bremen" collection	Pagina / Page 25
Collezione "Salisburgo" / "Salzburg" collection	Pagina / Page 26
Collezione "Stoccolma" / "Stockholm" collection	Pagina / Page 27
Collezione "Helsinki" / "Helsinki" collection	Pagina / Page 28
Collezione "Milano" / "Milan" collection	Pagina / Page 29
Collezione "Parigi" / "Paris" collection	Pagina / Page 30-31
Collezione "Atene" / "Athens" collection	Pagina / Page 32-33
Collezione "Vienna" / "Wien" collection	Pagina / Page 34-35
Collezione "Praga" / "Prague" collection	Pagina / Page 36-37
Collezione "Copenaghen" / "Copenhagen" collection	Pagina / Page 38-39
Collezione "Amsterdam" / "Amsterdam" collection	Pagina / Page 40
Collezione "Dublino" / "Dublin" collection	Pagina / Page 41
Collezione "Stile antico" / "Antique style" collection	Pagina / Page 42
Collezione "Provenza" / "Provence" collection	Pagina / Page 44

Ferramenta per porte e finestre / Door and window hardware

Battenti / Door knockers	Pagina / Page 43
Placche per lettere / Letter plates	Pagina / Page 43
Pomoli / Door knobs	Pagina / Page 44
Maniglioni / Door pull handles	Pagina / Page 45-48
Maniglioni per alzanti scorrevoli / Lift and slide handles	Pagina / Page 49
Maniglie per porte scorrevoli / Sliding door pulls	Pagina / Page 49
Maniglie ad anello / Ring turn handles	Pagina / Page 49
Cremonesi per aste esterne / Cremona bolts for external rods	Pagina / Page 50-51
Dry keep con serratura / Lockable tilt and turn handle	Pagina / Page 52
Serrature da applicare / Rim locks	Pagina / Page 52-53
Catenacci / Bolts	Pagina / Page 54
Saltarelli e chiavistelli / Thumbblatches and latches	Pagina / Page 55
Nottolini WC / Privacy snibs	Pagina / Page 56
Rosette strette per maniglie / Narrow escutcheons	Pagina / Page 56
Cerniere / Hinges	Pagina / Page 57
Fasce per porte / Door kick plates	Pagina / Page 58
Supporti per corrimano / Holder for handrail	Pagina / Page 58
Copricerniere / Hinge covers	Pagina / Page 58
Appendiabiti e grucce / Coat hooks and hangers	Pagina / Page 59
Numeri civici / Civic numbers	Pagina / Page 60
Accessori Vari / Small accessories	Pagina / Page 60
Placche strette per maniglie / Narrow handle backplates	Pagina / Page 61

Maniglie di sicurezza / Security door handles

Rosette e bocchette di sicurezza / Security rosettes	Pagina / Page 61
Maniglie di sicurezza classiche / Classic security sets	Pagina / Page 62
Maniglie di sicurezza rustiche / Rustic security sets	Pagina / Page 63
Maniglie di sicurezza su rosetta / Security sets with rosettes	Pagina / Page 64
Maniglie di sicurezza con placca Hardox® / Security door handles Hardox® backplate	Pagina / Page 65

Ferramenta per mobili / Cabinet hardware

Maniglie per mobili / Furniture handles	Pagina / Page 66
Accessori per mobili / Furniture accessories	Pagina / Page 67
Pomoli porcellana "Bavaria" / Furniture knobs "Bavaria" porcelain	Pagina / Page 68
Pannelli espositori / Advertising display boards	Pagina / Page 69
Informazioni sui nostri prodotti / Product information	Pagina / Page 70-71



Collezione **“Roma”**

“Rome” Collection

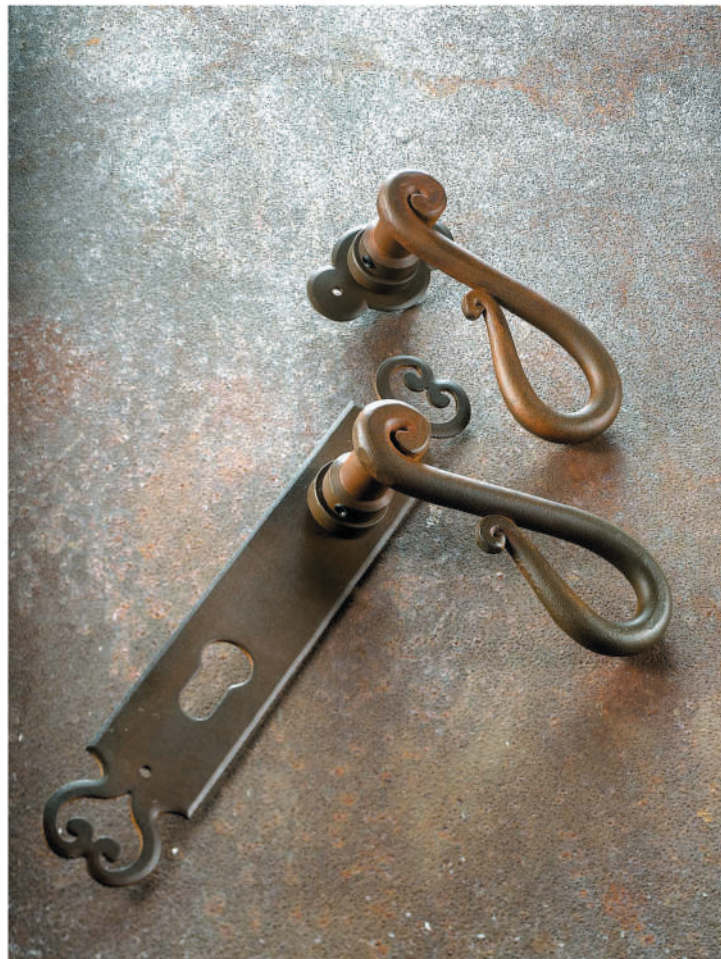

Antichizzato ruggine - Antique rust



Art. 2203/319



Cremonese AP per aste esterne
Cremonese bolt for external rod

Art. 2203/319

Impugnatura - 115 mm
Handle - 115 mm

Placca a scatola - 125x32 mm
Raised backplate - 125x32 mm

Martellina - Cremonese
Window handle - Cremonese bolt

Art. 2204

Impugnatura - 115 mm
Handle - 115 mm

Placca a scatola - 135x35x11 mm
Raised backplate - 135x35x11 mm



Art. 2204



Art. 2200



Art. 2201



Art. 2205 dx



Art. 2203



Art. 2202



Maniglia per porta
Door handle

Art. 2200

Impugnatura - 125 mm
Handle - 125 mm

Placca - 260x40x2 mm
Backplate - 260x40x2 mm



Maniglia per porta
Door handle

Art. 2201

Impugnatura - 125 mm
Handle - 125 mm

Rosetta - Bocchetta - 72x40x2 mm
Rosette - Escutcheon plate - 72x40x2 mm



Martellina D K - Dry keep

Art. 2205

Impugnatura - 125 mm
Handle - 125 mm

Scatola - 65x32x12 mm
Raised backplate - 65x32x12 mm



Martellina - Cremonese
Window handle - Cremonese bolt

Art. 2203

Impugnatura - 115 mm
Handle - 115 mm

Placca - 200x40x2 mm
Backplate - 200x40x2 mm



Martellina con rosetta
Window handle with rosette

Art. 2202

Impugnatura - 115 mm
Handle - 115 mm

Rosetta - 72x40x2 mm
Rosette - 72x40x2 mm



Collezione

“Londra”

“London” Collection



Nero antico - Antique black



Art. 2304



Martellina
Window handle

Art. 2304

Impugnatura - 110 mm
Handle - 110 mm

Placca - 118x50x2 mm
Backplate - 118x50x2 mm

Martellina - Cremonese
Window handle - Cremonese bolt

Art. 2305

Impugnatura - 110 mm
Handle - 110 mm

Placca a scatola - 135x35x11 mm
Raised backplate - 135x35x11 mm



Art. 2305



Art. 2300

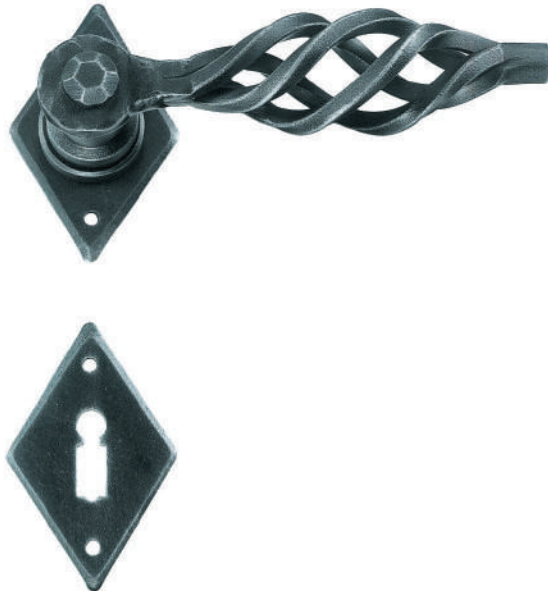

Art. 2301



Art. 2302

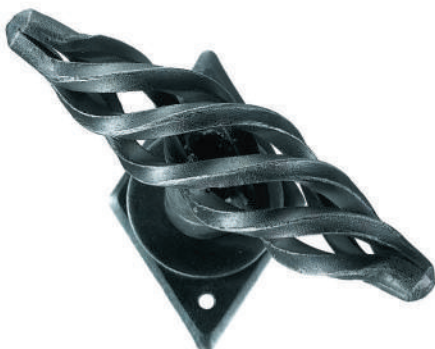

Art. 2303



Art. 2306



Maniglia per porta
Door handle

Art. 2300

Impugnatura - 125 mm
Handle - 125 mm

Placca - 245x45x2 mm
Backplate - 245x45x2 mm



Maniglia per porta
Door handle

Art. 2301

Impugnatura - 125 mm
Handle - 125 mm

Rosetta - Bocchetta - 70x45x2 mm
Rosette - Escutcheon plate - 70x45x2 mm



Maniglia per porta
Door handle

Art. 2302

Impugnatura - 125 mm
Handle - 125 mm

Rosetta - Bocchetta - Ø50x2 mm
Rosette - Escutcheon plate - Ø50x2 mm



Martellina con rosetta
Window handle with rosette

Art. 2303

Impugnatura - 110 mm
Handle - 110 mm

Rosetta - 70x45x2 mm
Rosette - 70x45x2 mm



Martellina D K - Dry keep

Art. 2306

Impugnatura - 125 mm
Handle - 125 mm

Scatola - 65x32x12 mm
Raised backplate - 65x32x12 mm



Collezione "Oslo"

"Oslo" Collection



Nero bronzato - *Bronze black*



Art. 2403



Martellina
Window handle

Art. 2403

Impugnatura - 111 mm
Handle - 111 mm

Placca - 140x40x2 mm
Backplate - 140x40x2 mm

Martellina - Cremonese
Window handle - Cremonese bolt

Art. 2404

Impugnatura - 111 mm
Handle - 111 mm

Placca a scatola - 135x35x11 mm
Raised backplate - 135x35x11 mm



Art. 2404



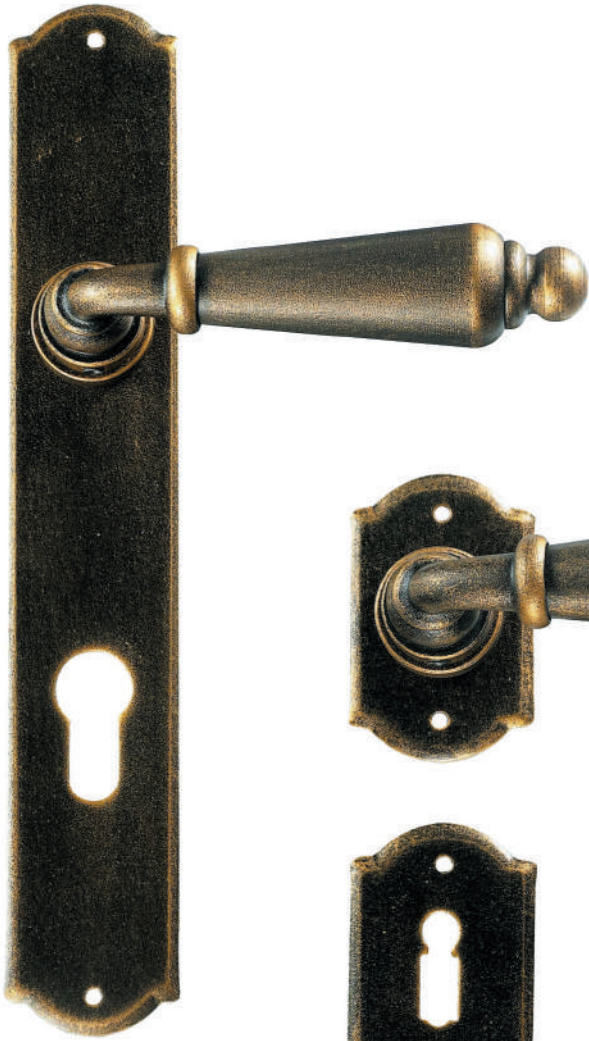

Art. 2400

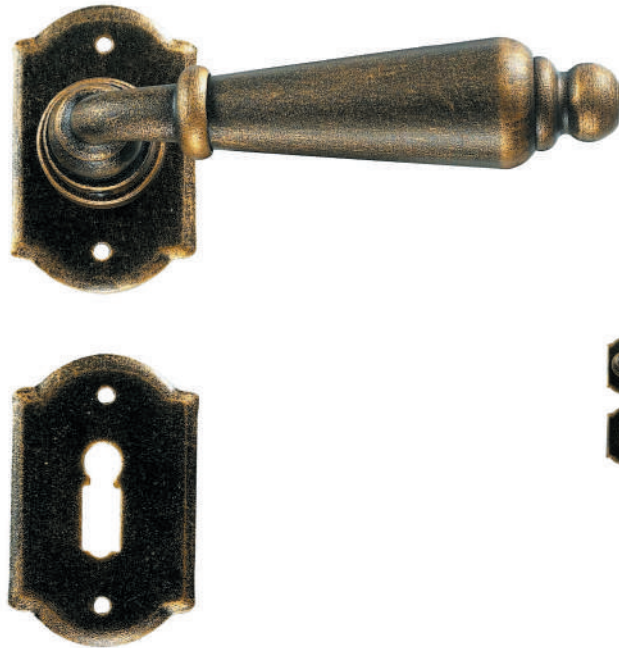

Art. 2401



Maniglia per porta
Door handle

Art. 2400

Impugnatura - 130 mm
 Handle - 130 mm

Placca - 240x40x2 mm
 Backplate - 240x40x2 mm



Maniglia per porta
Door handle

Art. 2401

Impugnatura - 130 mm
 Handle - 130 mm

Rosetta - Bocchetta - 64x40x2 mm
 Rosette - Escutcheon plate - 64x40x2 mm

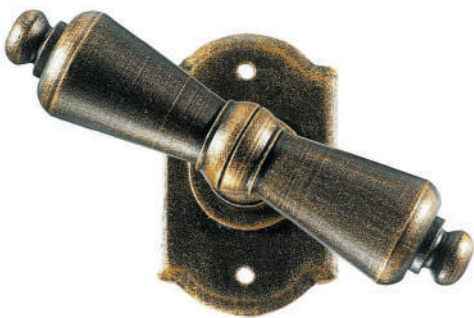

Art. 2402



Art. 2405



Martellina D K - Dry keep

Art. 2405

Impugnatura - 130 mm
 Handle - 130 mm

Scatola - 65x32x12 mm
 Raised backplate - 65x32x12 mm



Martellina con rosetta
Window handle with rosette

Art. 2402

Impugnatura - 111 mm
 Handle - 111 mm

Rosetta - 64x40x2 mm
 Rosette - 64x40x2 mm





Collezione

“Berlino”

“Berlin” Collection

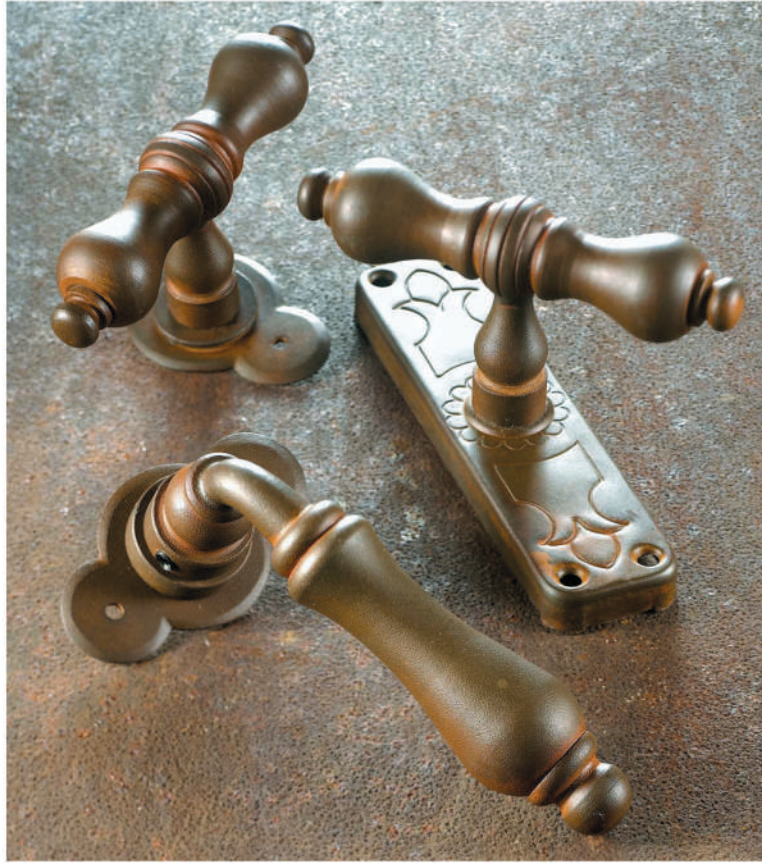

Antichizzato ruggine - Antique rust



Art. 2503



Martellina
Window handle

Art. 2503

Impugnatura - 112 mm
Handle - 112 mm

Placca - 200x40x2 mm
Backplate - 200x40x2 mm

Martellina - Cremonese
Window handle - Cremonese bolt

Art. 2504

Impugnatura - 112 mm
Handle - 112 mm

Placca a scatola - 135x35x11 mm
Raised backplate - 135x35x11 mm



Art. 2504



Art. 2500



Art. 2501



Art. 2502



Art. 2505



Maniglia per porta
 Door handle

Art. 2500

Impugnatura - 125 mm
 Handle - 125 mm

Placca - 250x40x2 mm
 Backplate - 250x40x2 mm



Maniglia per porta
 Door handle

Art. 2501

Impugnatura - 125 mm
 Handle - 125 mm

Rosetta - Bocchetta - 72x40x2 mm
 Rosette - Escutcheon plate - 72x40x2 mm



Martellina D K - Dry keep

Art. 2505

Impugnatura - 125 mm
 Handle - 125 mm

Scatola - 65x32x12 mm
 Raised backplate - 65x32x12 mm



Martellina con rosetta
 Window handle with rosette

Art. 2502

Impugnatura - 112 mm
 Handle - 112 mm

Rosetta - 72x40x2 mm
 Rosette - 72x40x2 mm





Collezione

“Madrid”

“Madrid” Collection



Nero antico - Antique black



Art. 2102



Martellina - Cremonese
Window handle - Cremonese bolt

Art. 2102

Impugnatura - 115 mm
Handle - 115 mm

Placca - 200x40x2 mm
Backplate - 200x40x2 mm

Martellina - Cremonese
Window handle - Cremonese bolt

Art. 2099

Impugnatura - 115 mm
Handle - 115 mm

Placca a scatola - 135x35x11 mm
Raised backplate - 135x35x11 mm



Art. 2099

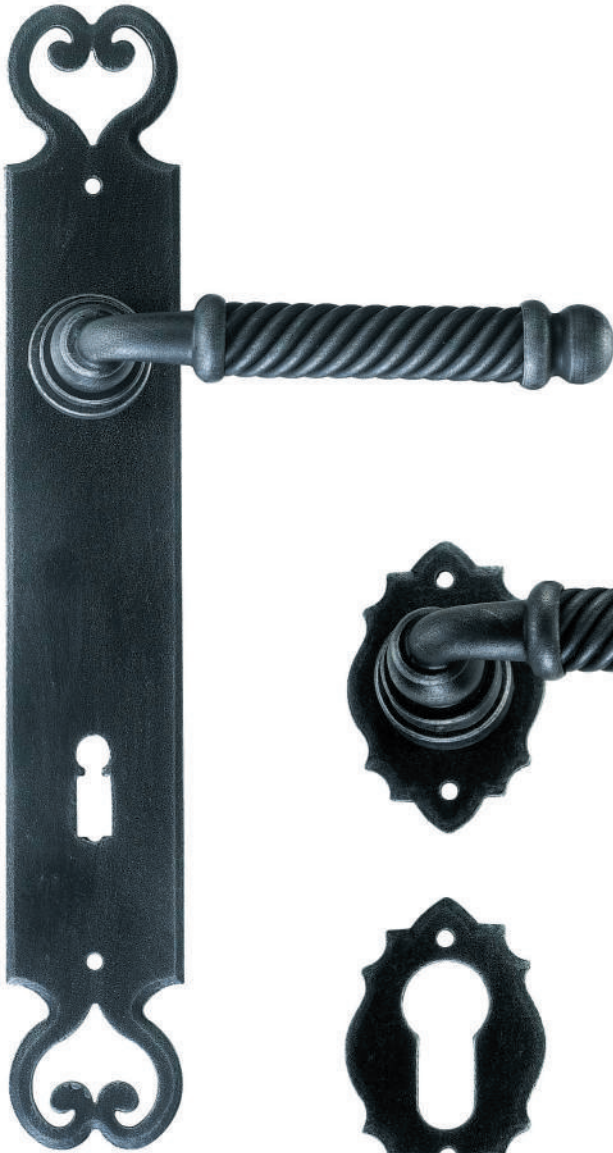

Art. 2100



Art. 2101



Art. 2098



Art. 2103



Maniglia per porta
 Door handle

Art. 2100

Impugnatura - 120 mm
 Handle - 120 mm

Placca - 260x40x2 mm
 Backplate - 260x40x2 mm



Maniglia per porta
 Door handle

Art. 2101

Impugnatura - 120 mm
 Handle - 120 mm

Rosetta - Bocchetta - 60x40x2 mm
 Rosette - Escutcheon plate - 60x40x2 mm



Martellina D K - Dry keep

Art. 2103

Impugnatura - 120 mm
 Handle - 120 mm

Scatola - 65x32x12 mm
 Raised backplate - 65x32x12 mm



Martellina con rosetta
 Window handle with rosette

Art. 2098

Impugnatura - 115 mm
 Handle - 115 mm

Rosetta - 60x40x2 mm
 Rosette - 60x40x2 mm

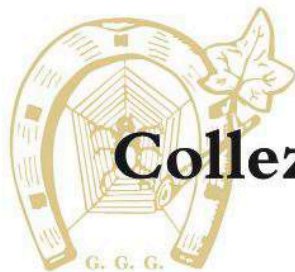

Collezione

“Lisbona”

“Lisbon” Collection

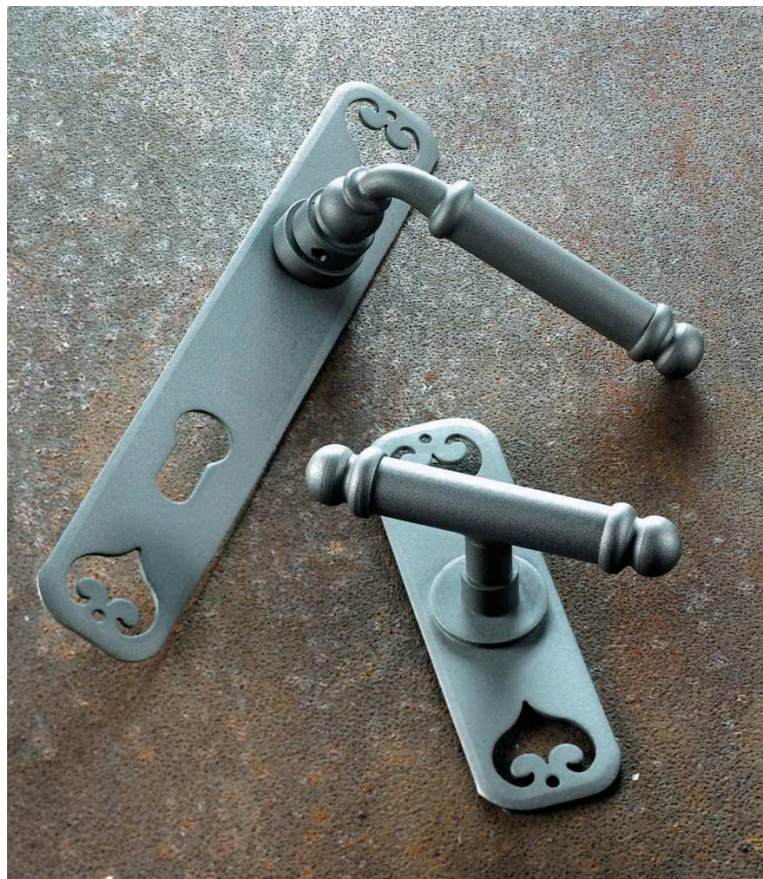

Grigio ferro chiaro - *Light grey*

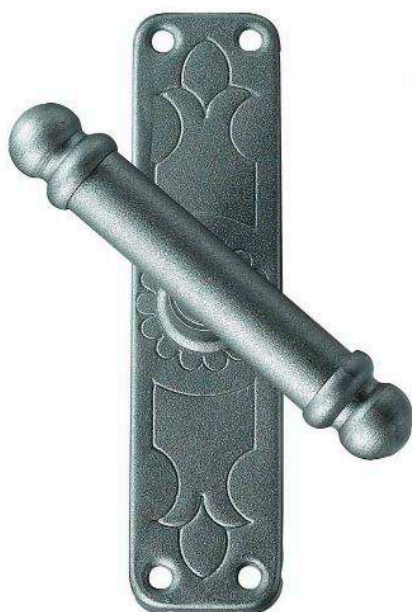

Art. 2107



Martellina - Cremonese
Window handle - Cremonese bolt

Art. 2107

Impugnatura - 105 mm
Handle - 105 mm

Placca a scatola - 135x35x11 mm
Raised backplate - 135x35x11 mm

Martellina
Window handle

Art. 2106

Impugnatura - 105 mm
Handle - 105 mm

Placca - 140x40x2 mm
Backplate - 140x40x2 mm

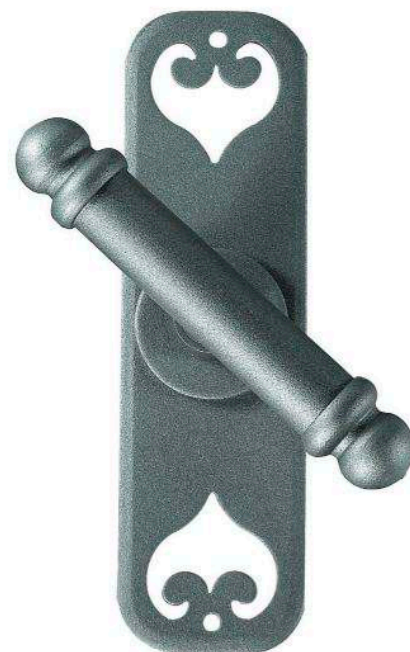

Art. 2106



Art. 2104

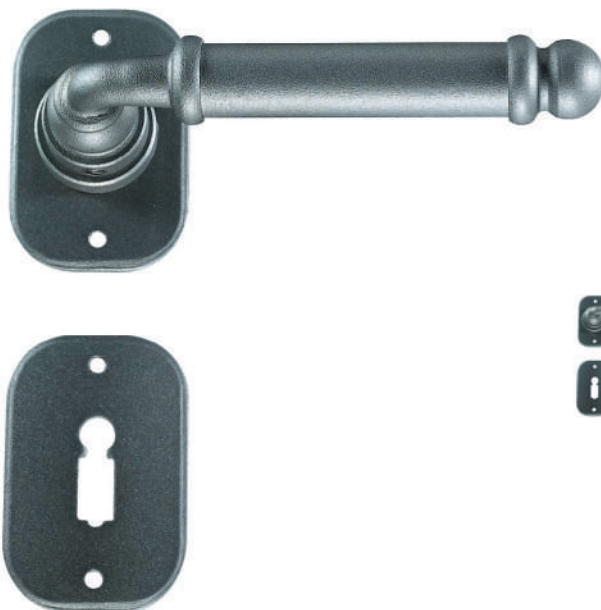

Art. 2105

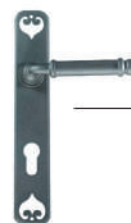

Maniglia per porta
 Door handle

Art. 2104

Impugnatura - 120 mm
 Handle - 120 mm

Placca - 240x40x2 mm
 Backplate - 240x40x2 mm



Maniglia per porta
 Door handle

Art. 2105

Impugnatura - 120 mm
 Handle - 120 mm

Rosetta - Bocchetta - 60x40x2 mm
 Rosette - Escutcheon plate - 60x40x2 mm

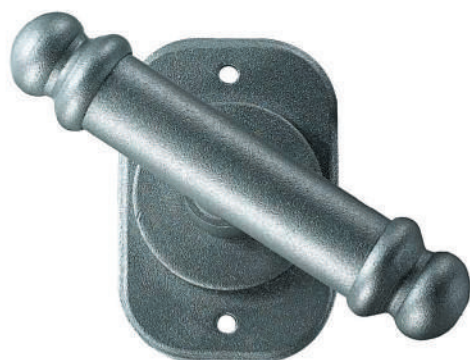

Art. 2097



Art. 2108



Martellina D K - Dry keep

Art. 2108

Impugnatura - 120 mm
 Handle - 120 mm

Scatola - 65x32x12 mm
 Raised backplate - 65x32x12 mm



Martellina con rosetta
 Window handle with rosette

Art. 2097

Impugnatura - 105 mm
 Handle - 105 mm

Rosetta - 60x40x2 mm
 Rosette - 60x40x2 mm



Collezione

“Berna”

“Bern” Collection



Nero ramato - Copper black



Art. 2111



Martellina - Cremonese
Window handle - Cremonese bolt

Art. 2111

Impugnatura - 100 mm
Handle - 100 mm

Placca a scatola - 135x35x11 mm
Raised backplate - 135x35x11 mm

Cremonese AP per aste esterne
Cremonese bolt for external rod

Art. 2111/319

Impugnatura - 100 mm
Handle - 100 mm

Placca a scatola - 125x32 mm
Raised backplate - 125x32 mm



Art. 2111/319



Art. 2109



Art. 2094



Maniglia per porta
 Door handle

Art. 2094

Impugnatura - 120 mm
 Handle - 120 mm

Rosetta - Bocchetta - 66x30x2 mm
 Rosette - Escutcheon plate - 66x30x2 mm



Maniglia per porta
 Door handle

Art. 2109

Impugnatura - 120 mm
 Handle - 120 mm

Placca - 250x45x2 mm
 Backplate - 250x45x2 mm



Maniglia per porta
 Door handle

Art. 2110

Impugnatura - 120 mm
 Handle - 120 mm

Rosetta - Bocchetta - 60x40x2 mm
 Rosette - Escutcheon plate - 60x40x2 mm



Art. 2110



Martellina con rosetta
 Window handle with rosette

Art. 2096

Impugnatura - 100 mm
 Handle - 100 mm

Rosetta - 60x40x2 mm
 Rosette - 60x40x2 mm



Martellina con rosetta
 Window handle with rosette

Art. 2095

Impugnatura - 100 mm
 Handle - 100 mm

Rosetta - 66x30x2 mm
 Rosette - 66x30x2 mm

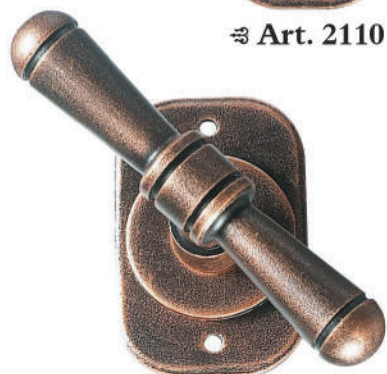

Art. 2096



Art. 2112

Art. 2095



Martellina DK - Dry keep

Art. 2112

Impugnatura - 120 mm
 Handle - 120 mm

Scatola - 65x32x12 mm
 Raised backplate - 65x32x12 mm

Collezione Mosca

Moscow collection



Art.2700

Impugnatura/Lever 125mm
Placca/Plate 240X40mm
Art.2700/M con molla di ritorno
Art.2700/M with return spring



Art.2696

Impugnatura/Lever 125mm
Placca/Plate 260X40mm
Art.2696/M con molla di ritorno
Art.2696/M with return spring



Art.2703

Impugnatura/Lever 100mm
Placca/Plate 140X40X2mm



Art.2704

Impugnatura/Lever 100mm
Placca/Plate 135X35X11mm



Art.2701

Impugnatura/Lever 125mm
Rosette/Rosettes 64X40mm
Art.2701/M con molla di ritorno
Art.2701/M with return spring



Art.2705

Impugnatura/Lever 125mm
Placca/Plate 65X32X12mm



Art.2699

Impugnatura/Lever 125mm
Rosette/Rosettes Ø50mm
Art.2699/M con molla di ritorno
Art.2699/M with return spring



Art.2702

Impugnatura/Lever 100mm
Rosetta/Rosette 64X40mm



Art.2698

Impugnatura/Lever 125mm
Rosette/Rosettes 66X30mm
Art.2698/M con molla di ritorno
Art.2698/M with return spring



Art.2702/2095

Impugnatura/Lever 100mm
Rosetta/Rosette 66X30mm

Collezione Budapest

Budapest collection



Art.2800

Impugnatura/Lever 125mm
Placca/Plate 250X40mm
Art.2800/M con molla di ritorno
Art.2800/M with return spring



Art.2805

Impugnatura/Lever 125mm
Placca/Plate 65X32X12mm



Art.2801

Impugnatura/Lever 125mm
Rosette/Rosettes 72x40mm
Art.2801/M con molla di ritorno
Art.2801/M with return spring





Art.2798

Impugnatura/Lever 125mm
Rosette/Rosettes 66x30mm
Art.2798/M con molla di ritorno
Art.2798/M with return spring



Art.2804

Impugnatura/Lever 100mm
Placca/Plate 135X35X11mm



Art.2799

Impugnatura/Lever 125mm
Rosette/Rosettes Ø50mm
Art.2799/M con molla di ritorno
Art.2799/M with return spring



Art.2803

Impugnatura/Lever 100mm
Placca/Plate 200X40mm



Art.2802

Impugnatura/Lever 100mm
Rosetta/Rosette 72X40mm

Collezione Tassin

Tassin collection



Art.1900

Impugnatura/Lever 110mm
Placca/Plate 220X40mm
Art.1900/M con molla di ritorno
Art.1900/M with return spring



Art.1899

Impugnatura/Lever 110mm
Placca/Plate 240X40mm
Art.1899/M con molla di ritorno
Art.1899/M with return spring



Art.1901

Impugnatura/Lever 110mm
Rosette/Rosettes 50X40mm
Art.1901/M con molla di ritorno
Art.1901/M with return spring



Art.1902

Impugnatura/Lever 110mm
Rosette/Rosettes 64X40mm
Art.1902/M con molla di ritorno
Art.1902/M with return spring





Art.1903

Impugnatura/*Lever* 110mm
Rosette/*Rosettes* 70X45mm
Art.1903/M con molla di ritorno
Art.1903/M with return spring



Art.1907

Maniglia per finestra □ 7mm
Int. 43mm Viti M5X30
Rosetta 66X30mm
DK Window Handle □7mm
Axe 43mm Screws M5X30
Rosette 66X30mm



Art.1904

Impugnatura/*Lever* 110mm
Rosette/*Rosettes* 66X30mm
Art.1904/M con molla di ritorno
Art.1904/M with return spring



Art.1905

Martellina DK
Scatola 65X32X12mm
DK Window Handle
Raised Backplate 65X32X12 mm

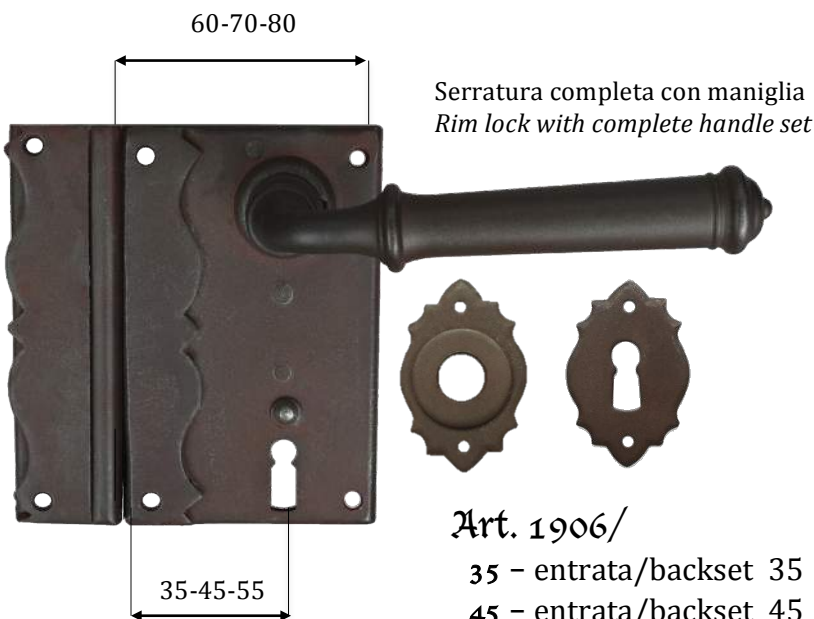

60-70-80

Serratura completa con maniglia
Rim lock with complete handle set

35-45-55

Art. 1906/
35 - entrata/backset 35
45 - entrata/backset 45
55 - entrata/backset 55



Art.14-10

Nottolino WC -Rosetta 50X40mm
□ 5-6-7-8 mm
Privacy snib -Rosette 50X40mm
□ 5-6-7-8 mm

Collezione **Monaco**

Munich collection



Art.2900

Impugnatura/Lever 115mm
Placca/Plate 240X40mm
Art.2900/M con molla di ritorno
Art.2900/M with return spring

Art.2899

Impugnatura/Lever 140mm
Placca/Plate 252X52mm
Art.2899/M con molla di ritorno
Art.2899/M with return spring



Art.2901

Impugnatura/Lever 115mm
Rosette/Rosettes Ø 50mm
Art.2901/M con molla di ritorno
Art.2901/M with return spring



Art.2905

Martellina DK
Scatola 65X32X12mm
DK Window Handle
Raised Backplate 65X32X12 mm



Art.2906

Maniglia per finestra □ 7mm
Int.43mm Viti M5X30
Rosetta 66X30mm
DK Window Handle □7mm
Axe 43mm Screws M5X30
Rosette 66X30mm

Collezione Brema

Bremen collection



Art.2950

Impugnatura/Lever 130mm
Placca/Plate 240X40mm
Art.2950/M con molla di ritorno
Art.2950/M with return spring



Art.2951

Impugnatura/Lever 130mm
Rosetta/Rosettes Ø 50mm
Art.2951/M con molla di ritorno
Art.2951/M with return spring



Art.2955

Martellina DK
Scatola 65X32X12mm
DK Window Handle
Raised Backplate 65X32X12 mm



Art.2956

Maniglia per finestra □ 7mm
Int.43mm Viti M5X30
Rosetta 66X30mm
DK Window Handle □7mm
Axe 43mm Screws M5X30
Rosette 66X30mm

Collezione Salisburgo

Salzburg collection



Art.2850

Impugnatura/Lever 125mm
Placca/Plate 240X40mm
Art.2850/M con molla di ritorno
Art.2850/M with return spring

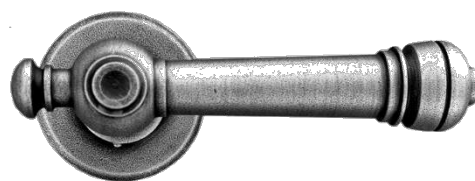

Art.2851

Impugnatura/Lever 125mm
Rosette/Rosettes Ø 50mm
Art.2851/M con molla di ritorno
Art.2851/M with return spring



Art.2855

Martellina DK
Scatola 65X32X12mm
DK Window Handle
Raised Backplate 65X32X12 mm



Art.2856

Maniglia per finestra □ 7mm
Int.43mm Viti M5X30
Rosetta 66X30mm
DK Window Handle □7mm
Axe 43mm Screws M5X30
Rosette 66X30mm

Collezione Stoccolma

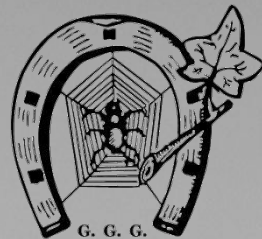

Stockholm collection



Art.1820

Impugnatura/*Lever* 110mm
Placca/*Plate* 220X40mm
Art.1820/M con molla di ritorno
Art.2850/M with return spring



Art.1821

Impugnatura/*Lever* 110mm
Rosette/*Rosettes* 50X40mm
Art.1821/M con molla di ritorno
Art.1821/M with return spring



Art.1822

Maniglia per finestra 86mm
Int.43mm Viti M5X30
Rosetta 75X30mm
DK Window Handle 86mm
Axe 43mm Screws M5X30
Rosette 75X30mm



Art.1823

Martellina DK
Scatola 65X32X12mm
DK Window Handle
Raised Backplate 65X32X12mm

Collezione Helsinki

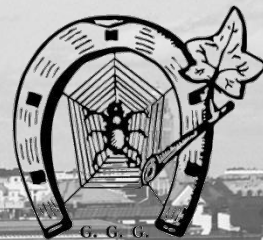

Helsinki collection



Art.1810

Impugnatura/Lever 100mm
Placca/Plate 240X30mm
Art.1810/M con molla di ritorno
Art.1810/M with return spring



Art.1811

Impugnatura/Lever 100mm
Rosette/Rosettes 66X30mm
Art.1811/M con molla di ritorno
Art.1811/M with return spring



Art.1812

Maniglia per finestra 86mm
Int.43mm Viti M5X30
Rosetta 66X30mm
DK Window Handle 86mm
Axe 43mm Screws M5X30
Rosette 66X30mm



Art.1813

Martellina DK
Scatola 65X32X12mm
DK Window Handle
Raised Backplate 65X32X12 mm

Collezione Misano



Misano collection



Art.1830

Impugnatura/Lever 120mm
Placca/Plate 220X30mm
Art.1830/M con molla di ritorno
Art.1830/M with return spring



Art.1831

Impugnatura/Lever 120mm
Rosette/Rosettes 50X40mm
Art.1831/M con molla di ritorno
Art.1831/M with return spring



Art.1833

Impugnatura/Lever 120mm
Rosette/Rosettes Ø 50mm
Art.1833/M con molla di ritorno
Art.1833/M with return spring



Art.1832

Maniglia per finestra 100mm
Int.43mm Viti M5X30
Rosetta 75X30mm
Window Handle 100mm
Axe 43mm Screws M5X30
Rosette 75X30mm



Art.1835

Martellina DK
Scatola 65X32X12mm
DK Window Handle
Raised Backplate 65X32X12 mm



Collezione

“Parigi”

“Paris” Collection



Antichizzato ruggine - *Antique rust*



☞ D23

☞ Art. 2603



Martellina
Window handle

Art. 2603 + D23

Impugnatura porcellana “Bavaria” - 112 mm
“Bavaria” porcelain handle - 112 mm

Piastra - 200x40x2 mm
Backplate - 200x40x2 mm

Martellina - Cremonese
Window handle - Cremonese bolt

Art. 2604 + D23

Impugnatura porcellana “Bavaria” - 112 mm
“Bavaria” porcelain handle - 112 mm

Placca a scatola - 135x35x11 mm
Raised backplate - 135x35x11 mm



☞ D23

☞ Art. 2604



Collezione **"Parigi"**
"Paris" Collection



☞ D22

☞ Art. 2600



☞ D22



☞ Art. 2601



☞ D22

☞ Art. 2605



☞ D22



☞ Art. 3-10



☞ D23

☞ Art. 2602



Maniglia per porta - Door handle

Art. 2600 + D22

Impugnatura porcellana "Bavaria" - 125 mm
"Bavaria" porcelain handle - 125 mm

Placca - 260x40x2 mm
Backplate - 260x40x2 mm



Maniglia per porta - Door handle

Art. 2601 + D22

Impugnatura porcellana "Bavaria" - 125 mm
"Bavaria" porcelain handle - 125 mm

Rosetta - Bocchetta - 60x40x2 mm
Rosette - Escutcheon plate - 60x40x2 mm



Maniglia per porta - Door handle

Art. 3-10 + D22

Impugnatura porcellana "Bavaria" - 125 mm
"Bavaria" porcelain handle - 125 mm

Rosetta - Bocchetta - Ø50x2 mm
Rosette - Escutcheon plate - Ø50x2 mm



Martellina D K - Dry keep

Art. 2605 + D22

Impugnatura porcellana "Bavaria" - 125 mm
"Bavaria" porcelain handle - 125 mm

Scatola - 65x32x12 mm
Raised backplate - 65x32x12 mm



**Martellina con rosetta
Window handle with rosette**

Art. 2602 + D23

Impugnatura porcellana "Bavaria" - 112 mm
"Bavaria" porcelain handle - 112 mm

Rosetta - 60x40x2 mm
Rosette - 60x40x2 mm



Collezione “Atene”

“Athens” Collection



Nero antico - Antique black



⌘ D21

⌘ Art. 2613/319



Cremonese AP per aste esterne
Cremonese bolt for external rods

Art. 2613/319 + D21

Impugnatura porcellana “Bavaria” - 112 mm
 “Bavaria” porcelain handle - 112 mm

Placca Scatola - 125x32 mm
 Raised backplate - 125x32 mm

Martellina - Cremonese
Window handle - Cremonese bolt

Art. 2613 + D21

Impugnatura porcellana “Bavaria” - 112 mm
 “Bavaria” porcelain handle - 112 mm

Placca a scatola - 135x35x11 mm
 Raised backplate - 135x35x11 mm



⌘ D21

⌘ Art. 2613



D20

Art. 2609



D20

Art. 2610



D21

Art. 2611



D21

Art. 2612



D20

Art. 2615



Maniglia per porta - Door handle

Art. 2609 + D20

Impugnatura porcellana "Bavaria" - 125 mm
"Bavaria" porcelain handle - 125 mm

Placca - 250x45x2 mm
Backplate - 250x45x2 mm



Maniglia per porta - Door handle

Art. 2610 + D20

Impugnatura porcellana "Bavaria" - 125 mm
"Bavaria" porcelain handle - 125 mm

Rosetta - Bocchetta - 60x40x2 mm
Rosette - Escutcheon plate - 60x40x2 mm



**Martellina con rosetta
Window handle with rosette**

Art. 2611 + D21

Impugnatura porcellana "Bavaria" - 112 mm
"Bavaria" porcelain handle - 112 mm

Rosetta - 66x30x2 mm
Rosette - 66x30x2 mm



Martellina - Window handle

Art. 2612 + D21

Impugnatura porcellana "Bavaria" - 112 mm
"Bavaria" porcelain handle - 112 mm

Piastra - 140x40x2 mm
Backplate - 140x40x2 mm



Martellina D K - Dry keep

Art. 2615 + D20

Impugnatura porcellana "Bavaria" - 125 mm
"Bavaria" porcelain handle - 125 mm

Scatola - 65x32x12 mm
Raised backplate - 65x32x12 mm



Collezione

“Vienna”

“Wien” Collection



Verde oro antico - *Antique gold green*



⌘ D2

⌘ Art. 1-40



Martellina
Window handle

Art. 1-40 + D2

Impugnatura porcellana “Bavaria” - 112 mm
“Bavaria” porcelain handle - 112 mm

Piastra - 200x40x2 mm
Backplate - 200x40x2 mm



⌘ D2

⌘ Art. 1-50

Martellina - Cremonese
Window handle - Cremonese bolt

Art. 1-50 + D2

Impugnatura porcellana “Bavaria” - 112 mm
“Bavaria” porcelain handle - 112 mm

Placca Scatola - 135x35x11 mm
Raised backplate - 135x35x11 mm



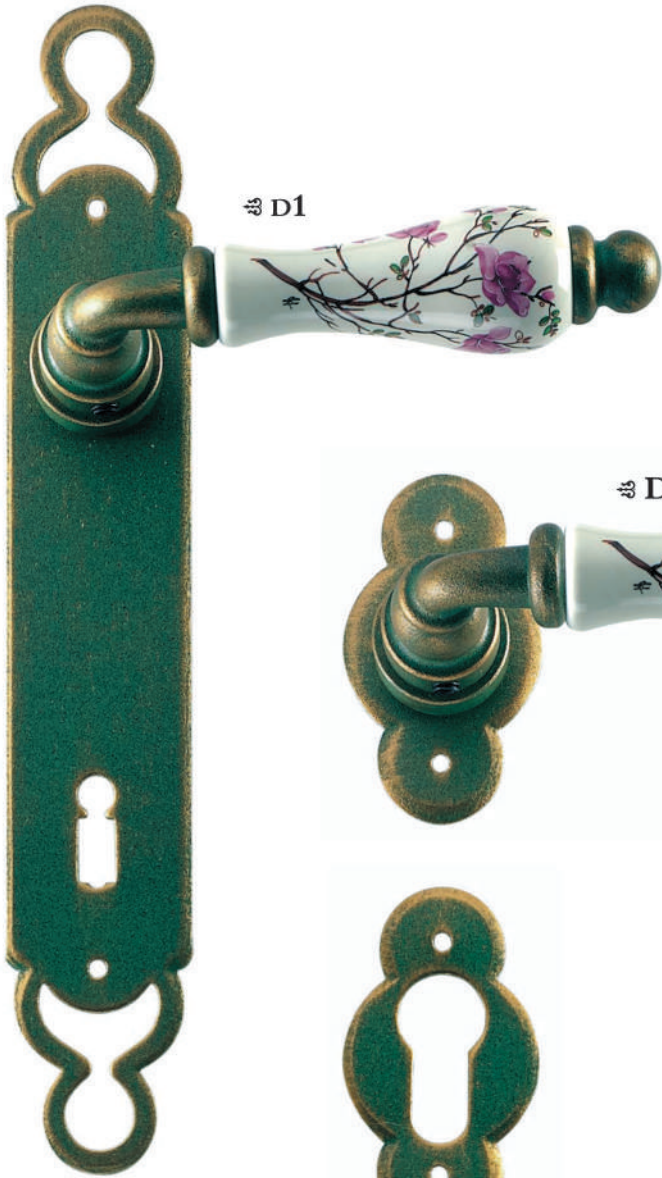

☞ D1

☞ Art. 1-10



Maniglia per porta - Door handle

Art. 1-10 + D1

Impugnatura porcellana “Bavaria” - 125 mm
 “Bavaria” porcelain handle - 125 mm

Placca - 250x40x2 mm
 Backplate - 250x40x2 mm

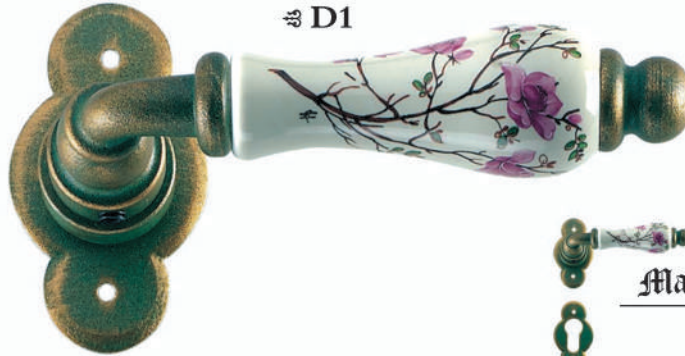

☞ D1

☞ Art. 1-20



Maniglia per porta - Door handle

Art. 1-20 + D1

Impugnatura porcellana “Bavaria” - 125 mm
 “Bavaria” porcelain handle - 125 mm

Rosetta - 72x40x2 mm
 Rosette - 72x40x2 mm

Bocchetta - 72x40x2 mm
 Escutcheon plate - 72x40x2 mm



Martellina con rosetta
Window handle with rosette

Art. 1-30 + D2

Impugnatura porcellana “Bavaria” - 112 mm
 “Bavaria” porcelain handle - 112 mm

Rosetta - 72x40x2 mm
 Rosette - 72x40x2 mm

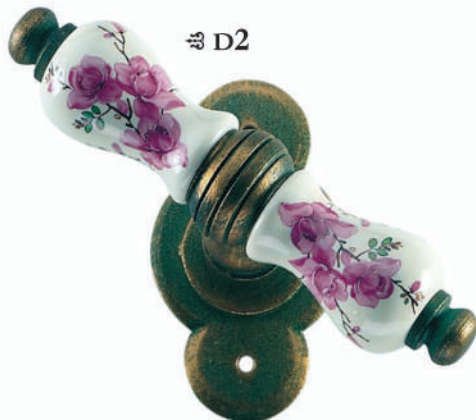

☞ D2

☞ Art. 1-30



☞ D1

☞ Art. 1-60



Martellina D K - Dry keep

Art. 1-60 + D1

Impugnatura porcellana “Bavaria” - 125 mm
 “Bavaria” porcelain handle - 125 mm

Scatola - 65x32x12 mm
 Raised backplate - 65x32x12 mm



Collezione

“Praga”

“Prague” Collection



Antichizzato ruggine - Antique rust



⌘ D6

⌘ Art. 2-40



Martellina
Window handle

Art. 2-40 + D6

Impugnatura porcellana “Bavaria” - 112 mm
“Bavaria” porcelain handle - 112 mm

Piastra - 140x40x2 mm
Backplate - 140x40x2 mm



⌘ D6

⌘ Art. 2-50

Martellina - Cremonese
Window handle - Cremona bolt

Art. 2-50 + D6

Impugnatura porcellana “Bavaria” - 112 mm
“Bavaria” porcelain handle - 112 mm

Placca a scatola - 135x35x11 mm
Raised backplate - 135x35x11 mm



Art. 2-10

D5



D5



Art. 2-20



Art. 5-90



D5



Art. 2-60

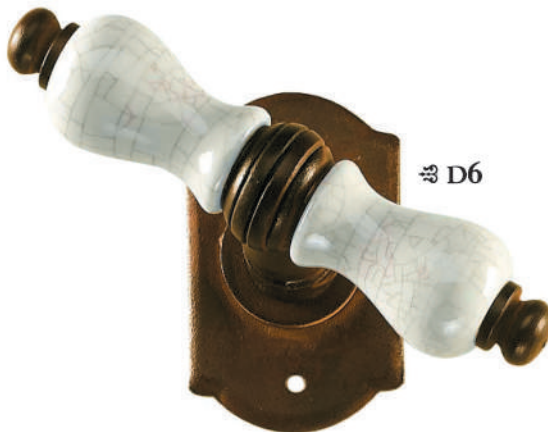

D6

Art. 2-30



Maniglia per porta - Door handle

Art. 2-10 + D5

Impugnatura porcellana "Bavaria" - 125 mm
"Bavaria" porcelain handle - 125 mm

Placca - 240x40x2 mm
Backplate - 240x40x2 mm



Maniglia per porta - Door handle

Art. 2-20 + D5

Impugnatura porcellana "Bavaria" - 125 mm
"Bavaria" porcelain handle - 125 mm

Rosetta - 64x40x2 mm
Rosette - 64x40x2 mm

Bocchetta - 64x40x2 mm
Escutcheon plate - 64x40x2 mm



Pendente - Pendant

Art. 5-90 Craquelè/Crackled

Pendente - 72 mm
Furniture pendant pull - 72 mm

Rosetta - Ø35 mm
Rosette - Ø35 mm



Martellina D K - Dry keep

Art. 2-60 + D5

Impugnatura porcellana "Bavaria" - 125 mm
"Bavaria" porcelain handle - 125 mm

Scatola - 65x32x12 mm
Raised backplate - 65x32x12 mm



**Martellina con rosetta
Window handle with rosette**

Art. 2-30 + D6

Impugnatura porcellana "Bavaria" - 112 mm
"Bavaria" porcelain handle - 112 mm

Rosetta - 64x40x2 mm
Rosette - 64x40x2 mm



Collezione

“Copenaghen”

“Copenhagen” Collection



Nero antico - Antique black



⌘ D10

⌘ Art. 2623



Martellina
Window handle

Art. 2623 + D10

Impugnatura porcellana “Bavaria” - 112 mm
“Bavaria” porcelain handle - 112 mm

Placca - 140x40x2 mm
Backplate - 140x40x2 mm



⌘ D10

⌘ Art. 2624

Martellina - Cremonese
Window handle - Cremonese bolt

Art. 2624 + D10

Impugnatura porcellana “Bavaria” - 112 mm
“Bavaria” porcelain handle - 112 mm

Placca a scatola - 135x35x11 mm
Raised backplate - 135x35x11 mm



Collezione **“Copenhagen”**
“Copenhagen” Collection



⌘ D9

⌘ Art. 2620



⌘ D9

⌘ Art. 2621



⌘ D9

⌘ Art. 3-10



⌘ D9

⌘ Art. 2625



⌘ D10

⌘ Art. 2622



Maniglia per porta - Door handle

Art. 2620 + D9

Impugnatura porcellana “Bavaria” - 125 mm
“Bavaria” porcelain handle - 125 mm

Placca - 240x40x2 mm
Backplate - 240x40x2 mm



Maniglia per porta - Door handle

Art. 2621 + D9

Impugnatura porcellana “Bavaria” - 125 mm
“Bavaria” porcelain handle - 125 mm

Rosetta - Bocchetta - 60x40x2 mm
Rosette - Escutcheon plate - 60x40x2 mm



Maniglia per porta - Door handle

Art. 3-10 + D9

Impugnatura porcellana “Bavaria” - 125 mm
“Bavaria” porcelain handle - 125 mm

Rosetta - Bocchetta - Ø50x2 mm
Rosette - Escutcheon plate - Ø50x2 mm



Martellina D K - Dry keep

Art. 2625 + D9

Impugnatura porcellana “Bavaria” - 125 mm
“Bavaria” porcelain handle - 125 mm

Scatola - 65x32x12 mm
Raised backplate - 65x32x12 mm



**Martellina con rosetta
 Window handle with rosette**

Art. 2622 + D10

Impugnatura porcellana “Bavaria” - 112 mm
“Bavaria” porcelain handle - 112 mm

Rosetta - 60x40x2 mm
Rosette - 60x40x2 mm

Collezione Amsterdam

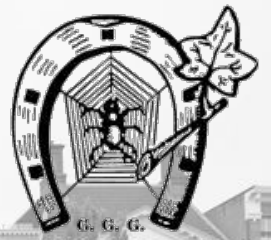

Amsterdam collection



D 13

Art.5-10

Impugnatura/Lever 125mm
Placca/Plate 220X40mm
Art.5-10/M con molla di ritorno
Art.5-10/M with return spring

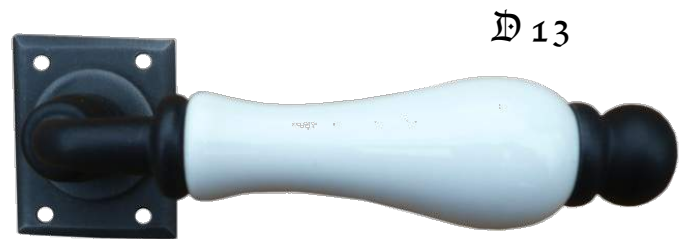

D 13

Art.5-20

Impugnatura/Lever 125mm
Rosette/Rosettes 50X40mm
Art.5-20 /M con molla di ritorno
Art.5-20/M with return spring



D 14

Art.5-40

Martellina DK 112mm
Scatola 65X32X12mm
DK Window Handle 112mm
Raised Backplate 65X32X12 mm



D 14

Art.5-30

Maniglia per finestra 112mm
Int.43mm Viti M5X30
Rosetta 75X30mm
Window Handle 112mm
Axe 43mm Screws M5X30
Rosette 75X30mm

Collezione Dublino



Dublin collection

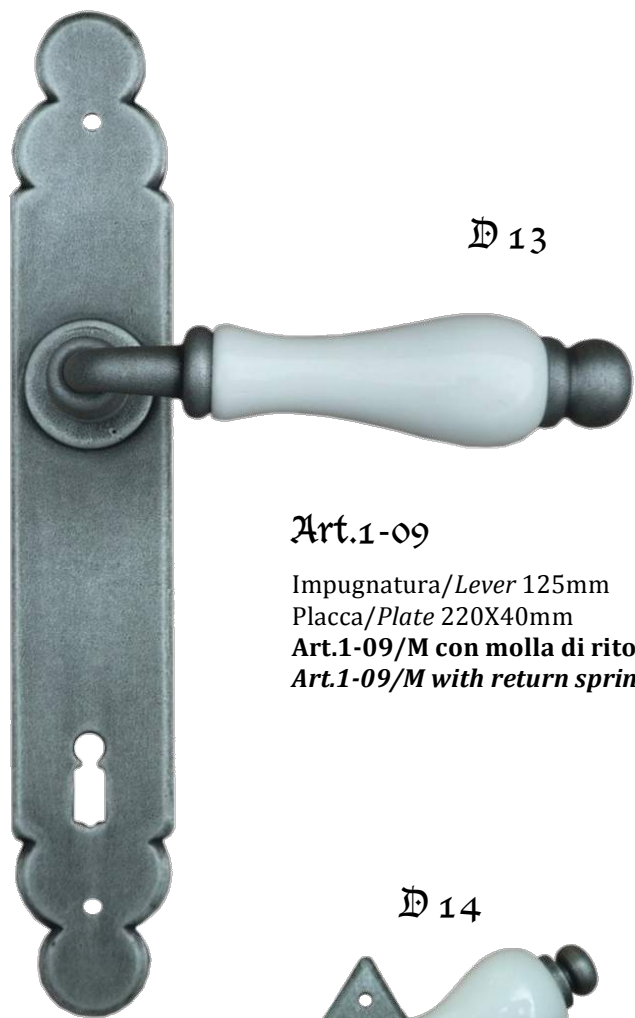

D 13

Art.1-09

Impugnatura/Lever 125mm
Placca/Plate 220X40mm
Art.1-09/M con molla di ritorno
Art.1-09/M with return spring



D 13

Art.4-10

Impugnatura/Lever 125mm
Rosette/Rosettes 70X45mm
Art.4-10 /M con molla di ritorno
Art.4-10/M with return spring



D 14

Art.4-20

Martellina 112mm
Rosetta 70X45mm
Window Handle 112mm
Rosette 70X30mm



D 13

Art.1-08

Impugnatura/Lever 125mm
Rosette/Rosettes 66X30mm
Art.1-08 /M con molla di ritorno
Art.1-08/M with return spring





Collezione "Stile Antico"

Maniglie e Maniglioni

"Antique Style" Collection

Door Handles and Pull handles



Maniglia per porta

Door handle

Art. 2220

Impugnatura - 130 mm
Handle - 130 mm

Placca - 250x45x4 mm
Backplate - 250x45x4 mm

Art. 2220



Art. 2214



Art. 2214/ZANC



Maniglione
Pull handle

Art. 2214

Maniglione - 320x30x30 mm
Pull handle - 320x30x30 mm

Rosette - 40x40 mm
Rosettes - 40x40 mm



Maniglione zancato
Cranked pull handle

Art. 2214/ZANC

Maniglione zancato - 320x30x30 mm
Pull handle - 320x30x30 mm

Rosette - 55x35 mm
Rosettes - 55x35 mm

Distanza sui centri - 30 mm
Distance between centres - 30 mm



Maniglia per porta
Door handle

Art. 2210

Impugnatura - 140 mm
Handle - 140 mm

Placca - 400x80x4 mm
Backplate - 400x80x4 mm



Art. 2210



Art. 2213



Art. 2213/ZANC



Maniglione
Pull handle

Art. 2213

Maniglione - 360xØ50 mm
Pull handle - 360xØ50 mm

Rosette - Ø60 mm
Rosettes - Ø60 mm



Maniglione zancato
Cranked pull handle

Art. 2213/ZANC

Maniglione zancato - 360xØ50 mm
Pull handle - 360xØ50 mm

Rosette - 55x35 mm
Rosettes - 55x35 mm

Distanza sui centri - 30 mm
Distance between centres - 30 mm

Battenti / Door knockers



Art. 1700

Anello/Ring ■ 18X18XØ150mm
Piastra/Plate 150X150



Art. 1701

Anello/Ring ■ 18X18XØ150mm
Placca/Plate Ø80mm



Art. 2217

Anello/Ring Ø115mm
Placca/Plate Ø70mm



Art. 2215

Anello/Ring Ø120mm
Battente/Door Knocker 250X150mm

Art. 2215/A

Anello/Ring Ø80mm
Battente/Door Knocker 150X100mm



Art. 2115

Anello/Ring Ø115mm
Placca/Plate 70X70mm



Art. 1702

Placca/Plate
190X50mm

Placche per lettere / Letter plates



Art. 239

Placca/Plate 310X80mm
Buca/Opening size 230X40mm



Art. 240

Placca/Plate 310X80mm
Buca/Opening size 230X40mm

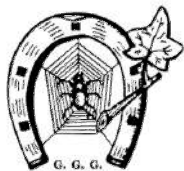

Pomoli / Door Knobs



Art. 2216

Art.2216/A
Pomolo/Knob Ø58mm
Art.2216/B
Pomolo/Knob Ø70mm



Art. 1704

Pomolo/Knob Ø70mm
Rosetta/Rosette 150X150mm



Art. 1703

Art.1703/A
Pomolo/Knob Ø58mm
Rosetta/Rosette Ø80mm
Art.1703/B
Pomolo/Knob Ø70mm
Rosetta/Rosette Ø80mm



Art. 2116

Pomolo/Knob Ø65mm
Rosetta/Rosette Ø80mm



Art. 2080

Pomolo/Knob Ø60mm



Art. 2081

Pomolo/Knob Ø50mm



Art. 2807

Pomolo/Knob Ø80mm
Rosetta/Rosette Ø70mm

Maniglia "Provenza" / Door handle "Provence"

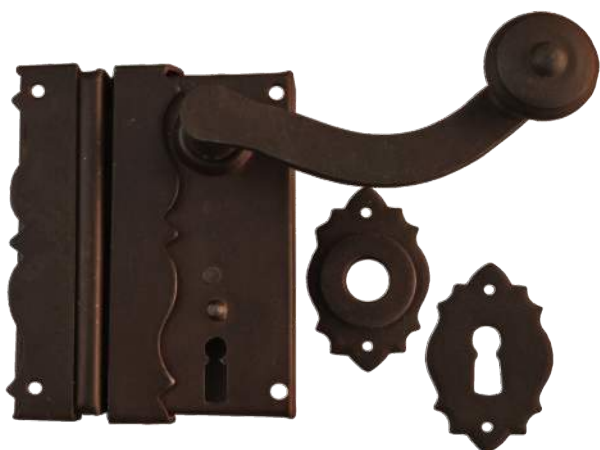

Art. 5-43/ 35-45-55

Serratura completa con maniglia
Rim lock with complete handle set

35 - entrata/backset 35
45 - entrata/backset 45
55 - entrata/backset 55



Art.4-43

Impugnatura/Lever 105mm
Rosette/Rosettes 70X45mm
Art.4-43/M con molla di ritorno
Art.4-43/M with return spring

Maniglioni/ Pull handles

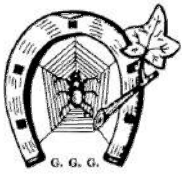

Art.2326
Maniglione/Door Pull
760X270mm ■25X25mm



Art.2327
Maniglione/Door Pull
730X200mm ■16X16mm



Art.2320
Maniglione/Door Pull 410mm - Ø25mm
Rosette/Rosettes Ø68mm



Art.2325
Maniglione/Door Pull
1000mm Ø35mm



Art.1879
Maniglione/Door Pull
620mm - ■20X20mm
Rosette/Rosettes 250X250mm



Art.2328/A
Maniglione/Door Pull
600mm Ø28mm

Art.2328/B
Maniglione/Door Pull
900mm Ø28mm

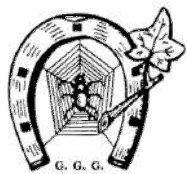

Maniglioni/ Pull handles



Art.2513

Maniglione/Door Pull
245mm Ø28mm
Rosette/Rosettes Ø40mm



Art.2513/Zanc



Art.2413

Maniglione/Door Pull
240mm Ø27mm
Rosette/Rosettes Ø40mm



Art.2413/Zanc



Art.5-50 +D...

Maniglione/Door Pull
250mm Ø28mm
Rosette/Rosettes Ø40mm



Art.5-50 /Zanc+D...



Art.2113

Maniglione/Door Pull
210mm Ø16mm
Rosette/Rosettes Ø40mm



Art.2113/Zanc

Maniglioni/ Pull handles

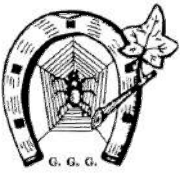

Art.2114

Maniglione/Door Pull 210mm Ø16mm
Rosette/Rosettes Ø40mm



Art.2114/Zanc



Art.2114

Maniglione/Door Pull 180mm
Placca/Plate 240X40mm



Art.2114/Zanc



Art.2119

Maniglione/Door Pull
280mm Ø24mm
Rosette/Rosettes Ø40mm



Art.2806/A

Maniglione/Door Pull
175mm Ø30mm
Rosette/Rosettes Ø40mm

Art.2806/B

Maniglione/Door Pull
245mm Ø30mm
Rosette/Rosettes Ø40mm



Art.2321

Maniglione/Door Pull
350mm Ø27mm
Rosette/Rosettes Ø50mm



Art.2322

Maniglione/Door Pull
315mm Ø27mm
Rosette/Rosettes Ø50mm

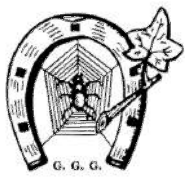

Maniglioni/ Pull handles

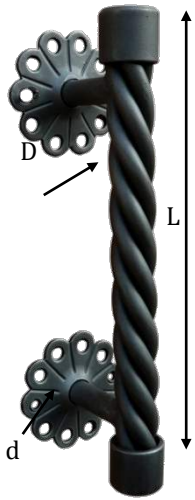

Art.1865 /

A D 20 L 200 d 20

B D 20 L 300 d 20

C D 25 L 400 d 25

D D 25 L 600 d 25

Maniglione
Pull handle

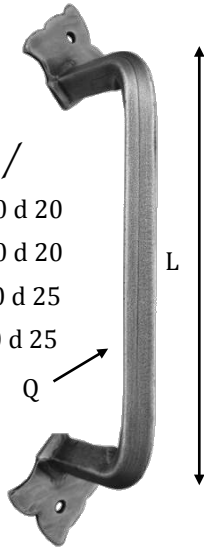

Art.1860 /

A Q 8X8 L 150

B Q 10X10 L 200

C Q 15X15 L 300

D Q 15X15 L 350

Maniglione
Pull handle

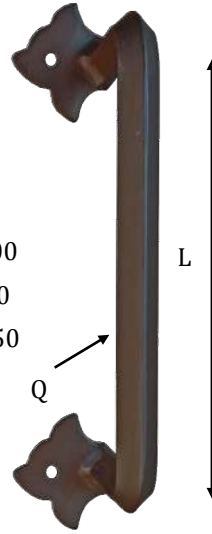

Art.1861 /

A Q 8X8 L 120

B Q 10X10 L 150

C Q 15X15 L 260

D Q 15X15 L 310

Maniglione zancato
Crancked pull handle



Maniglione
Pull handle

Art.1880 /

A L 600

B L 800

C L 1000

D L 1200

E L 1400

F L 1600

G L 1800

H L 2000



Art. 1870

Maniglione zancato
Crancked pull handle
Placca/ plate 310x80mm
Impugnatura/ lever Ø150x8x8mm



Art.1875

Maniglione zancato
Crancked pull handle
Placca/plate 170x80mm
Impugnatura/ lever Ø150x8x8mm



Art. 1877

Maniglione / Door pull
Placca/ Plate 240x30mm

Maniglioni per Alzanti Scorrevoli Lift and Slide Handles



Placca / Plate 224X40mm – Maniglia a conchiglia / Shell Handle 148X40mm

Quadro/ Spindle 10X10mm

Disponibile: Maniglione+maniglia conchiglia – Maniglione Yale+maniglia a conchiglia – Copia maniglioni Yale

Available: Pull+Shell handles – Pull with profile Cylinder hole + shall handle – Pair of profile cylinder pulls



Art.2509

Impugnatura/Lever: 215 mm



Art.2510

Impugnatura/Lever: 220 mm



Art.2512

Impugnatura/Lever: 240 mm



Art.2511+D...

Impugnatura/Lever: 220 mm

Maniglie per Scorrevoli / Sliding Door Pulls



Art.2128

Dimensioni:
148X40 mm
Prof: 10mm
Size:
148X40 mm
Depth: 10mm



Art.2129

Dimensioni:
148X40 mm
Prof: 10mm
Size:
148X40 mm
Depth: 10mm



Art.2130

Dimensioni:
125X40 mm
Prof: 13mm
Size:
125X40 mm
Depth: 13mm



Art.2131

Dimensioni:
125X40 mm
Prof: 13mm
Size:
125X40 mm
Depth: 13mm

Maniglie ad Anello/ Ring Turn Handles



Art.1837CP

Copia di maniglie ad anello
Pair of Turn Ring Handles
Anello/ Ring : 75mm
Rosetta/Rosette: 50mm
Altezza/Height: 90mm

Art.1837

Maniglia ad anello (pezzo)
Turn Ring Handle (each)



Art.1836CP

Copia di maniglie ad anello
Pair of Turn Ring Handles
Anello/ Ring : 65mm
Rosetta/Rosette: 50mm
Altezza/Height: 85mm

Art.1836

Maniglia ad anello (pezzo)
Turn Ring Handle (each)

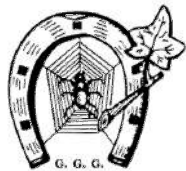

Cremonesi Aste Esterne

Cremonese Bolts for external rods



Art.327/2111



Art.127/111



Art.427/2705

Art.127/...

Cremonese per aste esterne 16X5mm
Placca 130X36X16sp - 5 accessori inclusi
*Cremonese bolt for external rods 16X5mm
Plate 130X36X16dep - 5 accessories included*

Art.327/...

Cremonese per aste esterne 16X8mm
Placca 148X42X20sp - 5 accessori inclusi
*Cremonese bolt for external rods 16X8mm
Plate 148X42X20dep - 5 accessories included*

Art.427/...

Cremonese falsa con mov. DK o Q.7mm
Placca 148X42X20sp - 5 accessori inclusi
*Dummy cremone bolt with tilt & turn
mechanism or 7mm spindle
Plate 148X42X20dep - 5 accessories included*



Art.430

Aste mezzo-tondo 16X8mm
Half-round rod 16X8mm

Art.431

Aste mezzo-tondo 16X5mm
Half-round rod 16X5mm

Le aste mezzo-tondo sono fornite separatamente.

The half-round rods are supplied separately.



Art.432/6/10/14/19

Spessori per art.327
2 pezzi possono essere montati insieme

*Height addition for art.327.
Max 2 pieces can be mounted together*

SP: 6-10-14-19mm

SP



Art.433

Passante
Rod cover



Art.327/111-Ser

Disponibile per tutti i modelli su ordinazione.
Richiedere preventivo e tempi di consegna

*Available for all models on request.
Please ask price and delivery time*



Cremonesi aste esterne

Cremona bolt for external rods



Art. .../2704



Art. .../2404



Art. ...+D10



Art. .../2107



Art. .../2504



Art. .../2099



Art. .../2804



Art. .../2204



Art. .../544



Art. .../1100



Art. .../549



Art. .../111



Art. .../545



Art. .../902



Art. .../541



Art. .../316



Art. .../317



Art. .../1094

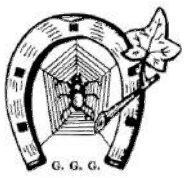

DK con serratura / Lockable tilt & turn



Art.227/2625+D9

Dimensioni:
Placca a scatola:
100X32X28mm
Raised Backplate:
100X32X28 mm



Art.227/2112

Dimensioni:
Placca a scatola:
100X32X28mm
Raised Backplate:
100X32X28 mm

DK con serratura è disponibile per tutte le impugnature
DK lockable is available on all types of levers

Serratura da applicare Entrare 35=45=55 mm Rim locks backset 35=45=55mm



Art.5850



Art.5850/Dek

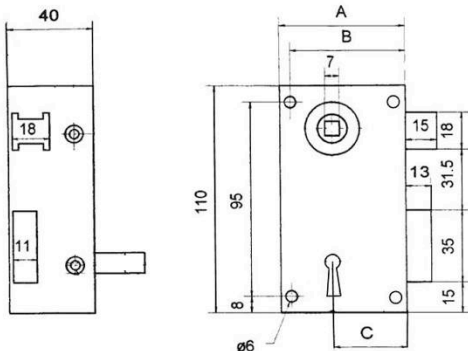

A	B	C
60	55	35
70	64	45
80	74	55

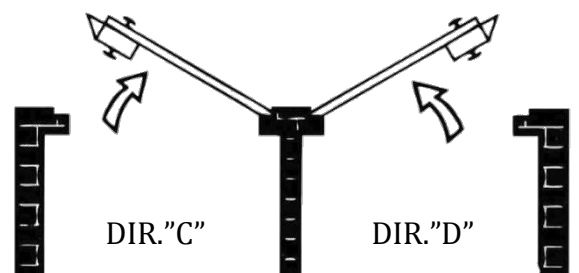
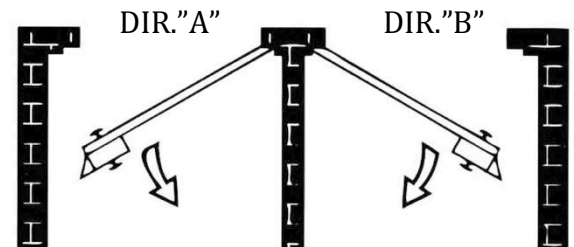

Le serrature sono fornite con 2 chiavi, rosetta e bocchetta esterne per art.5850/Dek oppure placca esterna per art.5850.
Impugnatura non è compresa

Serrature da Applicare

Rim Locks

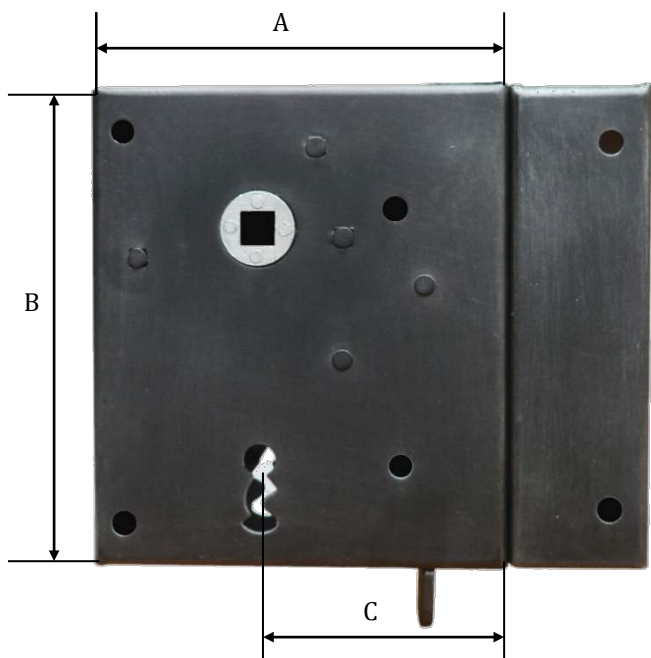
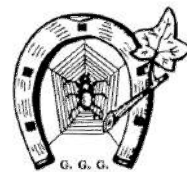

Art. 5800

Serratura da applicare patent A 101 B 117 C 60
Rim lock key A 101 B 117 C 60

Art. 5800/Yale

Serratura da applicare yale A 101 B 117 C 60
Rim lock with cylinder hole A 101 B 117 C 60

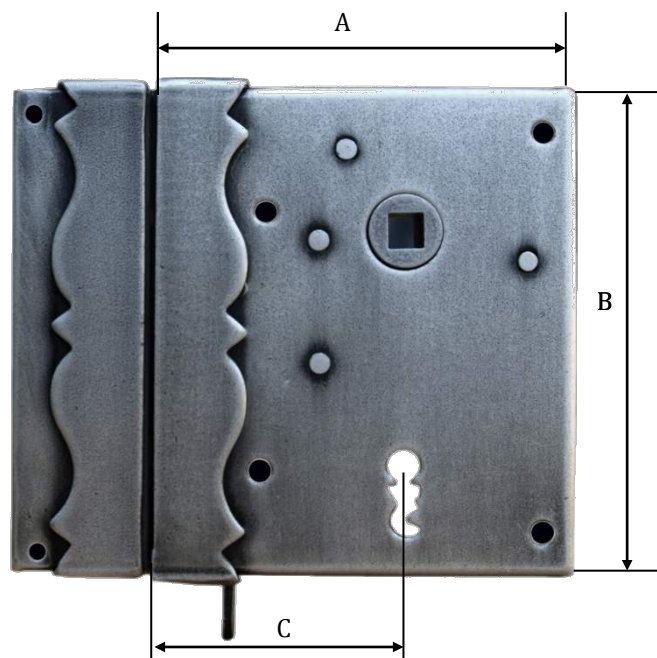

Art. 5800/Dek

Serratura da applicare con decoro patent A 101 B 117 C 60
Decorative rim lock key A 101 B 117 C 60

Art. 5800Dek/Yale

Serratura da applicare con decoro yale A 101 B 117 C 60
Decorative rim lock with cylinder hole A 101 B 117 C 60

Art. 5820

Serratura da applicare patent A 125 B 138 C 75
Rim lock key A 125 B 138 C 75

Art. 5820/Yale

Serratura da applicare yale A 125 B 138 C 75
Rim lock with cylinder hole A 125 B 138 C 75

Art. 5820/Dek

Serratura da applicare con decoro patent A 125 B 138 C 75
Decorative rim lock key A 125 B 138 C 75

Art. 5820Dek/Yale

Serratura da applicare con decoro yale A 125 B 138 C 75
Decorative rim lock with cylinder hole A 125 B 138 C 75

Le serrature sono fornite con 1 chiave standard, rosetta e bocchetta esterne e meccanismo "Made in Germany". Impugnatura e cilindro non sono compresi

Rim-locks are supplied with 1 standard key, external rosette and escutcheon, "Made in Germany" mechanism. Levers and eurocylinder are not included

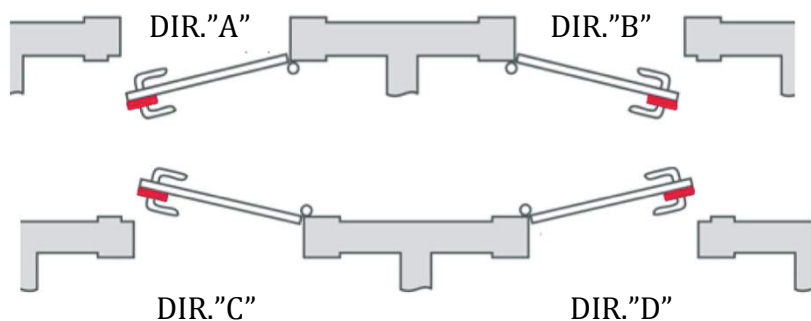

Serrature direzione "C" e "D" disponibili solo su ordinazione.
"C" and "D" direction rim locks are available only on



Chiave standard
Standard key



CH3
Chiave a richiesta
Key on request

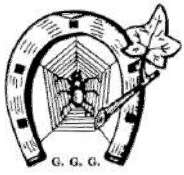

Catenacci / Bolts

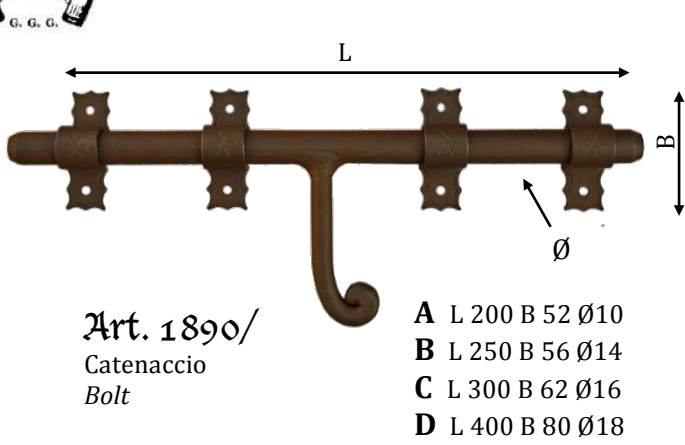

Art. 1890/
Catenaccio
Bolt

- A** L 200 B 52 Ø10
- B** L 250 B 56 Ø14
- C** L 300 B 62 Ø16
- D** L 400 B 80 Ø18

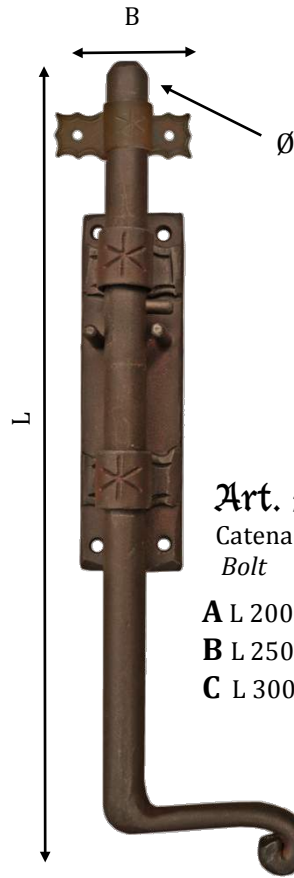

Art. 1891/
Catenaccio
Bolt

- A** L 200 B 30 Ø 10
- B** L 250 B 35 Ø 14
- C** L 300 B 40 Ø 16



A richiesta
con ginocchio
On Request
cranked bolt

Art. 1893/
Catenaccio
Bolt

- A** L 250
- B** L 400
- C** L 500

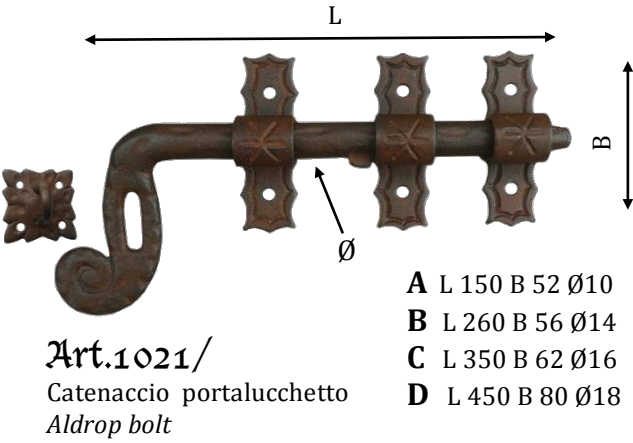

Art. 1021/
Catenaccio portallucchetto
Aldrop bolt

- A** L 150 B 52 Ø10
- B** L 260 B 56 Ø14
- C** L 350 B 62 Ø16
- D** L 450 B 80 Ø18

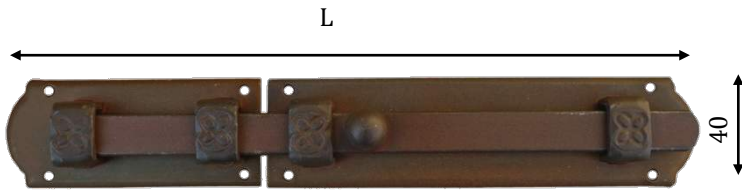

Art. 1892/
Catenaccio Traverso
Horizontal Bolt

- A** L 220
- B** L 270
- C** L 370



Art. 1894

Catenaccio Traverso 115x40mm
Horizontal Bolt 115x40mm

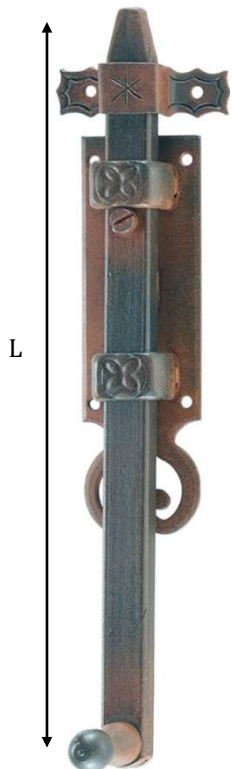

Art. 2117/
Catenaccio Traverso
Horizontal Bolt

- A** L 250
- B** L 300

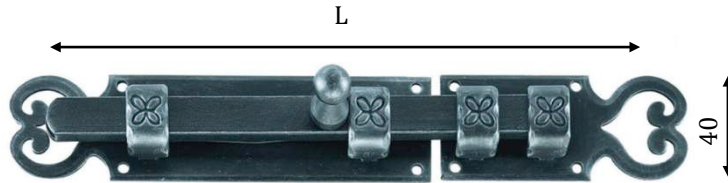

Art. 2118/
Catenaccio Traverso
Horizontal Bolt

- A** L 250
- B** L 300

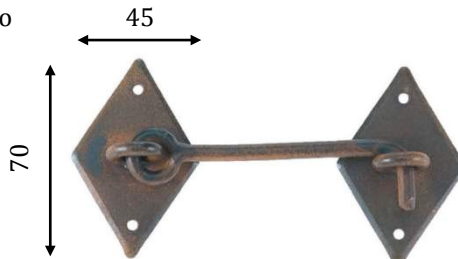

Art. 2132/

Chiavistello/Cabin hook
A 145mm- Asta/Hook 100mm
B 195mm- Asta/Hook 150mm

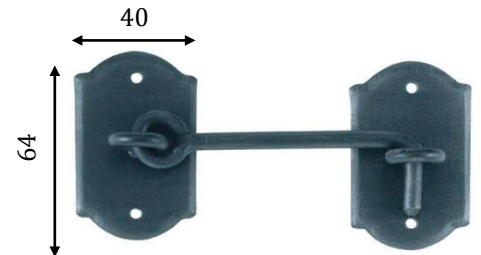

Art. 2133/

Chiavistello/Cabin hook
A 145mm- Asta/Hook 100mm
B 195mm- Asta/Hook 150mm

Saltarelli & Chiavistelli

Thumbblatches & Latches

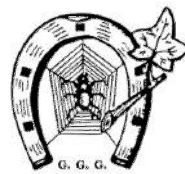

Art.1711

Saltarello/Thumbblatch
Asta/Bar: 190 mm
Placca/Backplate: 260X40mm



Art.1712

Saltarello/Thumbblatch
Asta/Bar: 190 mm
Placca/Backplate: 260X40mm



Art.1710

Saltarello/Thumbblatch
Asta/Bar: 190 mm
Placca/Backplate: 260X40mm



Art.1720

Chiavistello con quadro 8mm
Latch with spindle 8mm
Asta / Bar: 220 mm



Art.1714

Chiavistello/Latch
Asta/Bar: 220 mm
Rosetta/Rosette: 72X40mm



Art.1713

Chiavistello/Latch
Asta/Bar: 220 mm
Rosetta/Rosette: 50X40mm



Art.1715

Chiavistello/Latch
Asta/Bar: 220 mm
Rosetta/Rosette: 70X45mm



Art.1725

Chiavistello massiccio/Massive Latch
Asta/Bar: 400 mm
Piastre/Plates 125x60mm

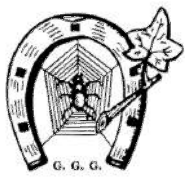

Mottolini WC / Privacy Snibs

Quadri disponibili/Available spindle sizes: 5-6-7-8mm



Art.6-10/WC
Rosetta/Rosette 72X40mm



Art.7-10/WC
Rosetta/Rosette 64X40mm



Art.8-10/WC
Rosetta/Rosette 70X45mm



Art.9-10/WC
Rosetta/Rosette 66X30mm



Art.10-10/WC
Rosetta/Rosette 60X40mm



Art.11-10/WC
Rosetta/Rosette Ø 50mm



Art.12-10/WC
Rosetta/Rosette 60X40mm



Art.14-10/WC
Rosetta/Rosette 50X40mm

Rosette Strette / Narrow Rosettes

Dimensioni rosette/Rosette dimensions: 68X25X4mm

Rosette lisce / Flat rosettes

Rosette martellate / Hammered rosettes



Art.1086/R Art.1086/B Art.1086/C



Art.1085/R Art.1085/B Art.1085/C

Cerniere / Hinges

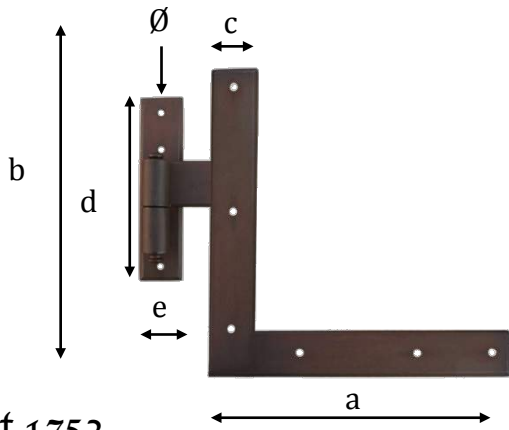
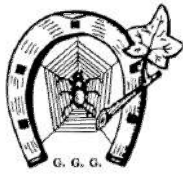

Art.1752

Squadra con cardine
Corner hinge with pivot

1752/A: a 400 b 300 c 40 ≠5mm Ø14mm d 170 e 40 f 22
1752/B: a 600 b 400 c 40 ≠ 5mm Ø14mm d170 e 40 f 22

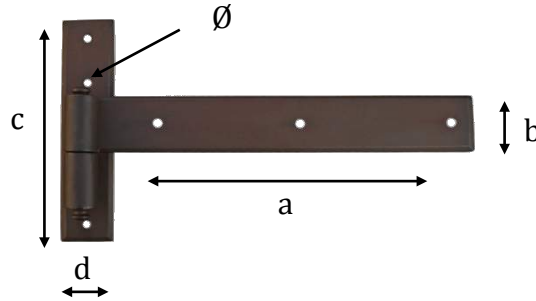
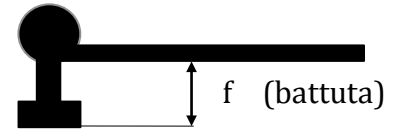
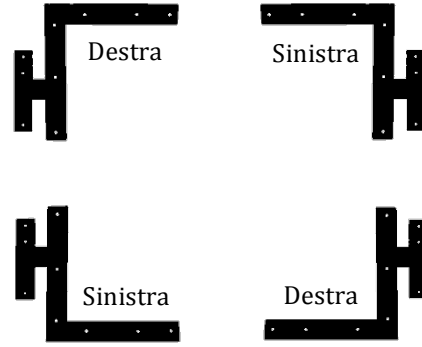

Art.1750

Bandella con cardine
Strap hinge with pivot

1750/A: a 300 b 40 ≠5mm Ø14mm c 170 d 40 f22
1750/B: a 400 b 40 ≠ 5mm Ø14mm c 170 d 40 f22
1750/C: a 500 b 40 ≠ 5mm Ø14mm c 170 d 40 f22
1750/D: a 600 b 40 ≠ 5mm Ø14mm c 170 d 40 f22

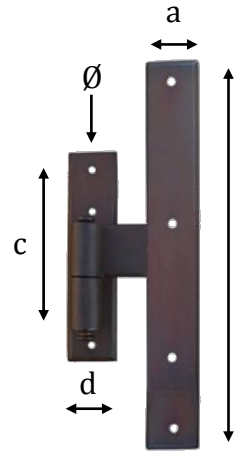

Art.1753

Bandella a "T" con cardine
"T" hinge with pivot

1753/A: a 40 b 300 ≠5mm c 170 d 40 Ø14 f22
1753/B: a 40 b 400 ≠ 5mm c 170 d 40 Ø14 f22

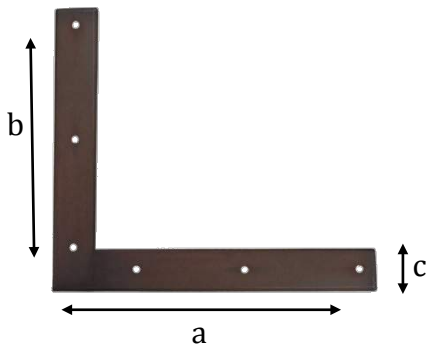

Art.1752F

Squadra rinforzo - Corner hinge

1752F/A: a 400 b 300 c 40 ≠5mm
1752F/B: a 600 b 400 c 40 ≠ 5mm

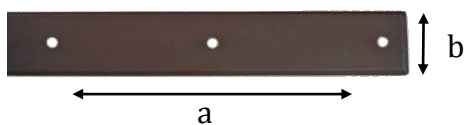

Art.1751

Bandella finta- False hinge

Art 1751/A: a 275 b 40 ≠5mm
Art 1751/B: a 375 b 40 ≠ 5mm
Art 1751/C: a 475 b 40 ≠ 5mm
Art 1751/D: a 575 b 40 ≠ 5mm

Su richiesta / On request



Art.51S/14

Cardine a vite 12 MA x110
Perno sfilabile



Art.1755

Cardine con piastra larghezza 30mm
Pivot with straight plate 30 mm.



Cerniera con cardine a filo/ Offset hinge



fasce per porte / Door kick plates

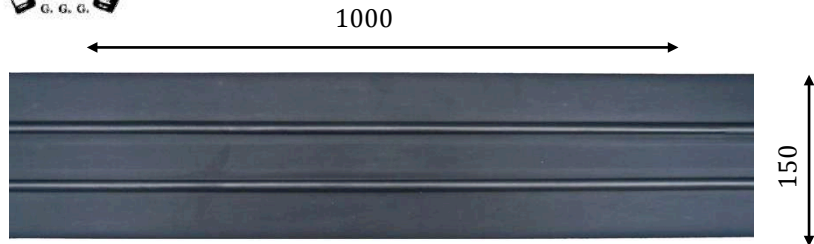

Art.1850*
Fascia per porta
Door kick plate

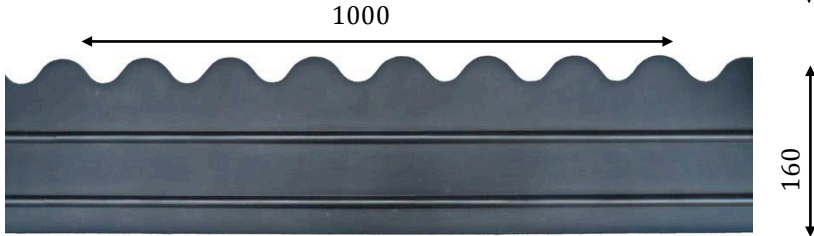

Art.1851*
Fascia per porta
Door kick plate

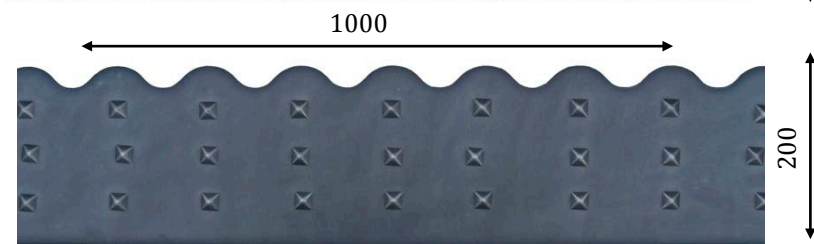

Art.1852*
Fascia per porta
Door kick plate

* Su richiesta lunghezza modificata
On request can be produced longer or shorter

Supporti per Corrimano / Holder for Handrail



Art.105/V
Rosetta: Ø 70mm
Sporgenza: 80 mm
Fissaggio a vite: M8x90mm
Rosette: Ø 70mm
Projection: 80 mm
Screw fixing: M8x90mm



Art.105
Rosetta: Ø 70mm
Sporgenza: 80 mm
Rosette: Ø 70mm
Projection: 80 mm

Copricerniere / Hinge Covers



Art.400
Art.400/14 Ø interno 14mm Altezza 98mm
Ø internal 14mm Size 98mm
Art.400/15 Ø interno 15mm Altezza 104mm
Ø internal 15mm Size 104mm
Art.400/16 Ø interno 16mm Altezza 110mm
Ø internal 16mm Size 110mm



Art.401
Art.401/14 Ø interno 14mm Altezza 80mm
Ø internal 14mm Size 80mm
Art.401/15 Ø interno 15mm Altezza 85mm
Ø internal 15mm Size 85mm
Art.401/16 Ø interno 16mm Altezza 90mm
Ø internal 16mm Size 90mm

Appendiabiti & Grucce

Coat Hooks & Hanger

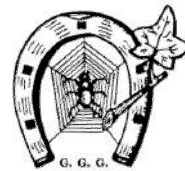

Art.1731

Appendiabito/ Coat Hook 115x80mm
Rosetta/ Rosette 72x40mm



Art.1732

Appendiabito/ Coat Hook 115x80mm
Rosetta/ Rosette 72x45mm



Art.58

Appendiabito 120mm
Coat Hook 120 mm



Art.789 + D...

Appendiabito/ Coat Hook 76mm
Rosetta/ Rosette 72x40mm



Art.790 + D...

Appendiabito/ Coat Hook 50mm
Rosetta/ Rosette 72x45mm



Art.56

Appendiabito 150mm
Coat Hook 150mm



Art.57

Appendiabito 120mm
Coat Hook 120mm



Art.1729

Gruccia appendiabito /Coat Hanger
220x400mm Ø 8mm



Art.791

Appendiabito/ Coat Hook
Rosetta/ Rosette 66x30mm



Art.788

Appendiabito 76mm
Coat Hook 76mm



Art.1730

Gruccia appendiabito /Coat Hanger
220x400mm ■ 8mm



Art.792

Appendiabito/ Coat Hook
Piastra/ Plate 240x40mm

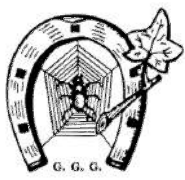

Numeri civici/ Civic Numbers



Art.200/0
120mm



Art.200/1
125mm



Art.200/2
120mm



Art.200/3
120mm



Art.200/4
120mm



Art.200/5
120mm



Art.200/6
120mm



Art.200/7
120mm



Art.200/8
120mm



Art.200/9
120mm



Art.200/A
65mm



Art.200/B
125mm



Art.200/C
65mm

Accessori Vari / Small accessories



Art.SQ
Lucchetto
Padlock

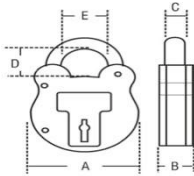

Art.SQ220 A38mm B14,5mm C7mm D11mm E12mm
Art.SQ440 A51mm B16,5mm C8mm D18mm E18mm
Art.SQ660 A64mm B19,7mm C10mm D21mm E21mm



Art.244
Campanello 90X85mm
Bell push 90X85mm



Art.242/
Rosetta con campanello
Door bell push
A Ø50 mm
B Ø60 mm
C Ø78 mm



Art.243
Campanello 64X40mm
Bell push 64X60mm



Art. 250
Catena di sicurezza per porta
Security door chain
Placca/Plate 140X40mm
Rosetta/Rosette 64X40mm



Art.251
Pomolo per cilindro 40mm - foro Ø 8 mm.
Knob for cylinder 40 mm - hole Ø 8 mm.

Placche Strette per Maniglie / Narrow handle backplates

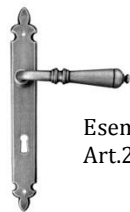
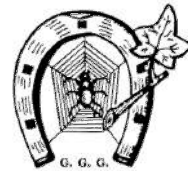

Esempio/Example
Art.2700/ST1

Art. ST1
Placca 250x30mm
Backplate 250x30mm



Esempio/Example
Art.2109/ST2

Art. ST2
Placca 240x30mm
Backplate 240x30mm



Esempio/Example
Art.2700/ST3

Art. ST3
Placca 220x30mm
Backplate 220x30mm

Rosette e bocchette di Sicurezza / Security Rosettes



Art.5030

Copia bocchette di sicurezza - foro yale
Security rosettes set - eurocylinder hole
Diametro/Diameter: 60 mm
Spessore Rosetta Esterna: 12 mm
Tickness External Rosette: 12 mm
Spessore Rosetta Interna: 6 mm
Tickness Internal Rosette: 6 mm



Art.5005

Rosetta interna /Internal rosette
Diametro/Diameter: 60mm
Foro/Hole: Ø18mm



Art.5040

Copia bocchette di sicurezza con defenfer
Security rosettes set -with Defenfer
Diametro/Diameter: 60 mm
Spessore Rosetta Esterna: 12 mm
Tickness External Rosette: 12 mm
Spessore Rosetta Interna: 6 mm
Tickness Internal Rosette: 6 mm



Art.5010

Copia bocchette di sicurezza - foro yale
Security rosettes set - eurocylinder hole
Diametro/Diameter: 60 mm
Spessore rosetta esterna: 12 mm
Tickness external rosette: 12 mm
Spessore rosetta interna: 6 mm
Tickness internal rosette: 6 mm



Art.5001

Rosetta interna /Internal rosette
Diametro/Diameter: 60mm
Foro/Hole: Ø18mm



Art.5020

Copia bocchette di sicurezza con defenfer
Security rosettes set -with Defenfer
Diametro/Diameter: 60 mm
Spessore rosetta esterna: 12 mm
Tickness external rosette: 12 mm
Spessore rosetta interna: 6 mm
Tickness internal rosette: 6 mm



Art.5044/DM
Rosetta martellata Ø50X2mm
Hammered Rosette Ø50X2mm



Art.5024/DM
Rosetta Ø50X2mm
Rosette Ø50X2mm



Maniglie di Sicurezza Classiche

Classic Security Sets



Placca Esterna: 250x55 mm, spessore 10 mm
 3 bussole filettate: 2 X M8 e 1 X M6.
 Placca in acciaio temprato a protezione del cilindro

Placca interna: 245 x 50 mm, spessore 3 mm
 fornita con 2 viti M8 e una vite M6
 A richiesta con defender (**specificare: + DEF**)

External plate: 250x55 mm, depth 10 mm
 invisible triple screwing: 2 X M8 e 1 X M6.
 Hardened internal profile for eurocylinder

Internal plate: 245 x 50 mm, depth 3 mm
 Supplied with 2 screws M8 e 1 screw M6

On request available with cylinder defender
 (specify in the order: + DEF)



Placca
 con Defender
 Plate with cylinder
 defender



Placca con pomolo
 zancato
 Plate with cranked
 knob



Art.4350

Art.4351

Art.4352

Art.4353



Art.4354

Art.4355

Art.4356



Art.4357

Art.4358

Art.4359

Art.4360

Art.... : A=Pom. centrale-Man.SX B=Pom centrale-Man.DX C=Pom.zancato SX-Man.DX D= Pom.zancato DX-Man.SX E= Maniglia-Maniglia
Art.... : A=Knob/Left hand lever B=Knob/Right hand lever C=Cranked knob left/Right hand lever D= Cranked knob right/Left hand lever E= Lever/Lever

Maniglie di Sicurezza Rustiche

Rustic Security Sets

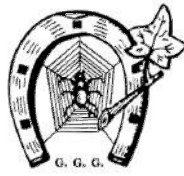

Placca Esterna: 250x55 mm, spessore 10 mm
 3 bussole filettate: 2 X M8 e 1 X M6.
 Placca in acciaio temprato a protezione del cilindro

Placca interna: 245 x 50 mm, spessore 3 mm
 fornita con 2 viti M8 e una vite M6
 A richiesta con defender (**specificare: + DEF**)

External plate: 250x55 mm, depth 10 mm
 invisible triple screwing: 2 X M8 e 1 X M6.
 Hardened internal profile for eurocylinder

Internal plate: 245 x 50 mm, depth 3 mm
 Supplied with 2 screws M8 e 1 screw M6

On request available with cylinder defender
 (specify in the order: + DEF)



Placca
 con Defender
 Plate with cylinder
 defender



Placca con pomolo
 zancato
 Plate with cranked
 knob



Art.4300

Art.4301

Art.4302

Art.4303



Art.4304



Art.4305



Art.4306



Art.4307



Art.4309



Art.4310



Art.4311

Art.... : A=Pom. centrale-Man.SX B=Pom centrale-Man.DX C=Pom.zancato SX-Man.DX D= Pom.zancato DX-Man.SX E= Maniglia-Maniglia
 Art.... : A=Knob/Left hand lever B=Knob/Right hand lever C=Cranked knob left/Right hand lever D= Cranked knob right/Left hand lever E= Lever/Lever



Maniglie di Sicurezza su Rosetta

Security Sets on Rosettes

Rosetta esterna: Ø60X12mm spessore, fornita con 2 bussole filettate M5 e a richiesta con defender
Placca Interna: Ø60X6mm spessore, fornita con 2 viti M5X70mm

External rosette: Ø60X12mm width, invisible double screwing
Internal rosette: Ø60X 6mm width, supplied with 2 screws M5X70mm

On request available with cylinder defender

Rosetta con defender
 Rosette with cylinder defender



Art.5350



Art.5351



Art.5352



Art.5353



Art.5354



Art.5355



Art.5356

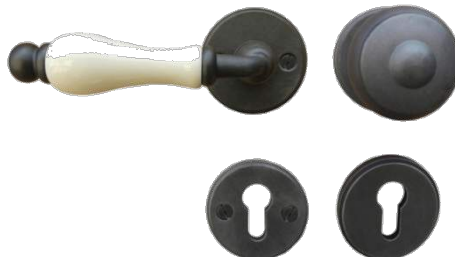

Art.5357+D...



Art.5358



Art.5360



Art.5300



Art.5301



Art.5305



Art.5307



Art.5311

Art.... : A=Pom. centrale-Man.SX B=Pom centrale-Man.DX C=Pom.zancato SX-Man.DX D= Pom.zancato DX-Man.SX E= Maniglia-Maniglia
 Art.... : A=Knob/Left hand lever B=Knob/Right hand lever C=Cranked knob left/Right hand lever D= Cranked knob right/Left hand lever E= Lever/Lever

Maniglie di Sicurezza con placca Hardox® Security door handles with hardox backplate®

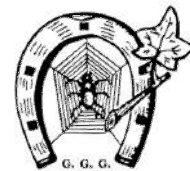

Placca Est.: Fornita con bussole filettate 2 xM5 e placca in acciaio a protezione del cilindro
Placca Interna: Fornita con 2 viti M5

External plate: invisible double screwing with M5 screws and hardened outside profile for cylinder
Internal plate: fixation with 2 screws M5



Art.4360



Art.4361



Art.4362



Art.4363 +D...



Art.4364



Art.4365



Art.4366



Art.4320



Art.4321



Art.4322



Art.4323



Art.4324



Art.4326



Art.4325



Art.4328

Art.... : A=Pom. centrale-Man.SX B=Pom centrale-Man.DX C=Pom.zancato SX-Man.DX D= Pom.zancato DX-Man.SX E= Maniglia-Maniglia
Art.... : A=Knob/Left hand lever B=Knob/Right hand lever C=Cranked knob left/Right hand lever D= Cranked knob right/Left hand lever E= Lever/Lever



Maniglie per mobili / Furniture Handles



Art.045
110mm-Rosette: Ø35mm
110mm-Rosettes: Ø35mm



Art.5-70+D6
112X55mm



Art.060/A 92mm
Art.060/B 105mm



Art.053
100X55mm Sporgenza
100X55mm Projection



Art.054
100X55mm Sporgenza
100X55mm Projection



Art.055
100X55mm Sporgenza
100X55mm Projection



Art.046/A
115mm-Rosette: Ø35mm
115mm-Rosettes: Ø35mm

Art.046/B
192mm-Rosette: Ø35mm
192mm-Rosettes: Ø35mm



Art.039/A 45mm Ros.35mm
Art.039/B 55mm Ros.35mm
Art.039/C 65mm Ros35mm



Art.047/A
85mm-Rosette: Ø35mm
85mm-Rosettes: Ø35mm

Art.047/B
120mm-Rosette: Ø35mm
120mm-Rosettes: Ø35mm



Art.028/A
Anello-Ring Ø35mm
Rosetta-Rosette 70x45mm
Art.028/B
Anello-Ring Ø40mm -
Rosetta-Rosette 70x45mm

Vert./Oriz. Reversibile
Vert./Oriz. Reversible



Art.038
Anello-Ring 42x45mm
Rosetta-Rosette 66x30mm

Vert./Oriz. Reversibile
Vert./Oriz. Reversible



Art.033/A
Anello-Ring Ø35mm
Rosetta/Rosette 85x35mm
Art.033/B
Anello-Ring Ø40mm
Rosetta-Rosette 85x35mm

Vert./Oriz. Reversibile
Vert./Oriz. Reversible



Art.057/A
Anello-Ring Ø35mm
Rosetta-Rosette 72x40mm
Art.057/B
Anello-Ring Ø40mm
Rosetta-Rosette 72x40mm

Vert./Oriz. Reversibile
Vert./Oriz. Reversible

Accessori per mobili / furniture accessories



Art.034/A
Anello / Ring Ø42mm
Rosetta / Rosette Ø35mm
Art.034
Solo anello / Only ring
Ø42mm



Art.036/A
Anello / Ring 42x45 mm
Rosetta / Rosette Ø35mm
Art.036
Solo anello / Only ring
42x45mm



Art.025/A
Anello / Ring Ø35mm -
Rosetta / Rosette Ø35mm

Art.025
Solo anello / Only ring Ø35mm

Art.026/A
Anello / Ring Ø40mm -
Rosetta / Rosette Ø35mm

Art.026
Solo anello / Only ring Ø40mm



Art.029/A
Anello / Ring Ø35mm -
Rosetta / Rosette Ø35mm

Art.029
Solo anello / Only ring Ø35mm

Art.030/A
Anello / Ring Ø40mm -
Rosetta / Rosette Ø35mm

Art.030
Solo anello / Only ring Ø40mm



Art.035/A 60mm -
Rosetta / Rosette Ø35mm

Art.035/B 80mm -
Rosetta / Rosette Ø35mm



Art.041
Ø42mm



Art.040
Ø35mm



Art.061
42X36mm



Art.044
Ø25mm



Art.043/A Ø25mm
Art.043/B Ø30mm
Art.043/C Ø35mm



Art.042
Ø30mm



Art.042/A
Ø30mm
Rosetta / Rosette: Ø35mm



Art.050/B
72X40mm



Art.050/A
40X72mm



Art.051/B
70X45mm



Art.050/A
45X70mm



Art.052/B
66X30mm



Art.052/A
30X66mm



Pomoli Porcellana "Babarria"

Knobs "Babarria" Porcelains



☞ Art. 01

Pomolo Ø25 mm - Rosetta Ø35 mm - Vite M4
Knob Ø25 mm - Rosette Ø35 mm - Screw M4



☞ Art. 02

Pomolo Ø30 mm - Rosetta Ø40 mm - Vite M4
Knob Ø30 mm - Rosette Ø40 mm - Screw M4



☞ Art. 03

Pomolo ovale 43x27 mm - Rosetta Ø40 mm - Vite M4
Oval knob 43x27 mm - Rosette Ø40 mm - Screw M4



☞ Art. 04

Pomolo Ø25 mm - Rosetta 72x40 mm - Vite M4
Knob Ø25 mm - Rosette 72x40 mm - Screw M4



☞ Art. 05

Pomolo Ø30 mm - Rosetta 72x40 mm - Vite M4
Knob Ø30 mm - Rosette 72x40 mm - Screw M4



☞ Art. 06

Pomolo ovale 43x27 mm - Rosetta 72x40 mm - Vite M4
Oval knob 43x27 mm - Rosette 72x40 mm - Screw M4



☞ Art. 07

Pomolo Ø25 mm - Rosetta 70x45 mm - Vite M4
Knob Ø25 mm - Rosette 70x45 mm - Screw M4



☞ Art. 08

Pomolo Ø30 mm - Rosetta 70x45 mm - Vite M4
Knob Ø30 mm - Rosette 70x45 mm - Screw M4



☞ Art. 09

Pomolo ovale 43x27 mm - Rosetta 70x45 mm - Vite M4
Oval knob 43x27 mm - Rosette 70x45 mm - Screw M4

Avorio con fiori "Primavera" Ivory with flowers "Spring"



☞ Art. D30



☞ Art. D31



☞ Art. D32

Avorio Craquelè Crackled Ivory



☞ Art. D33



☞ Art. D34



☞ Art. D35

Avorio Ivory



☞ Art. D36



☞ Art. D37



☞ Art. D38

Bianco White



☞ Art. D39



☞ Art. D40



☞ Art. D41

Pannelli espositori / Advertising display boards

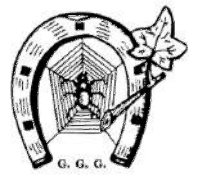

Pannello a due lati con ruote

Misure: 180x50 cm.

Base: 55x35 cm.

Two sides display board with wheels

Measures: 180x50 cm.

Basement: 55x35 cm.



Pannello a muro

Misure: 140x62 cm.

Hang display board

Measures: 140x62 cm.



Pannello a muro

Misure:
90x60 cm.
70x50 cm.
60x50 cm.
50x40 cm.
40x30 cm.

Hang display board

Measures:
90x60 cm.
70x50 cm.
60x50 cm.
50x40 cm.
40x30 cm.

Le nostre finiture - Finishes



Nero Antico NA
Antique Black NA



STRONG BLACK®



Antichizzato Ruggine AR
Antique Rust AR



Silver Zinc
Silver Zinc (Pewter)



Nero Zincato Z
Zinc-plated Z



Nero Bronzato
Bronze Black



Grigio Ferro Ant. GFA
Antique Grey Iron GFA



Nero Ramato
Copper Black



Bianco-Oro Antich.
Ant. Gold-White



Verde-Oro Antich
Ant. Gold-Green



Blu-Oro Antich
Ant. Gold-Blue



Rosso-Oro Antich.
Ant. Gold-Red



Grigio Ferro Chiaro GF
Light Grey GF



Oro Antico
Antique Gold

Finitura tipo "NA" nero antico: ferro sabbiato, verniciato nero a forno e antichizzato.

Finitura tipo "Strong Black": ferro sabbiato, zincato, verniciato nero a forno e antichizzato.

Finitura tipo "Z" zincato e antichizzato nero: ferro sabbiato, zincato, verniciato nero a forno e spazzolato.

Finiture tipo "Silver Zinc": Ferro sabbiato, zincato e antichizzato.

Finitura tipo "A.R." antichizzato ruggine. Essendo un procedimento naturale può variare da una forniture all'altra.

Finitura tipo "G.F." grigio ferro chiaro: ferro sabbiato, verniciato metallizzato.

Finitura tipo "G.F.A." grigio ferro antichizzato: ferro sabbiato, verniciato e spazzolato.

Finiture Verde oro antichizzato, rosso oro antichizzato, nero bronzato (nero oro), nero ramato (nero rame), blu antichizzato, bianco oro antichizzato, oro antico (non sfumato): Ferro sabbiato, verniciato e sfumato a mano con polvere oro o rame.

Le finiture speciali essendo fatte su specifica ordinazione possono comportare tempi di consegna più lunghi (minimo 15 giorni).

Qualora nelle ordinazioni non risulti espressamente specificata la finitura, le merce sarà da noi sempre consegnata con finitura standard Nero Antico.

Finish "NA" antique black. Sandblasted iron, black matt, antiqued.

Finish "Strong Black": Sandblasted iron, zinc-plated, black matt and antiqued.

Finish "Z" zinc-plated and antique black. Sandblasted iron, zinc-plated and brushed.

Finish Silver Zinc - zinc-plated and antiqued.

Finish "A.R." antique rust. Is obtained through a natural process and supplies may differ accordingly.

Finish "G.F." light grey. Sandblasted iron coloured.

Finish "G.F.A." antique grey iron. Sandblasted iron, coloured and brushed.

Finishes antique gold green, antique gold red, bronze black, copper black, antique blue, antique gold white, antique gold - sandblasted iron, coloured and shaded by hand.

Please note that for special finishes delivery time can be longer (minimum 15 days).

If finish is not expressly specified in the orders, goods will be delivered by us in Antique Black finish.

Porcellane "Bavaria" - "Bavaria" porcelains



Art. D5
Avorio Craquelè - *Crackled Ivory*



Art. D6



Art. D1
Avorio "Fiori di Pesco" - *Ivory with "Peach-Blossom"*



Art. D2



Art. D9
Avorio - *Ivory*



Art. D10



Art. D20
Bianco con "Fiori Blu" - *White with "Blue Flowers"*



Art. D21



Art. D13
Bianco - *White*



Art. D14



Art. D22
Avorio con fiori "Primavera" - *Ivory with flowers "Spring"*



Art. D23

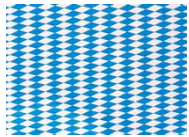

PORCELLANA ORIGINALE BAVARESE ORIGINAL BAVARIAN PORCELAIN

Le impugnature *craquelè* essendo realizzate con metodo artigianale possono variare nella concentrazione delle screpolature.
Crackled porcelains are produced using handicraft method and can vary in the concentration of cracks

FORATURE - KEY HOLES:

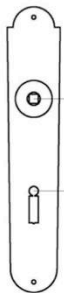

Patent - BB Hole

Italia	70/90 mm.
Germany	72 mm.
Switzerland	78 mm.
Austria	90 mm.
France	70 mm.
Russia	90 mm.
Greece	75/90 mm.
UK-Ireland	57 mm.

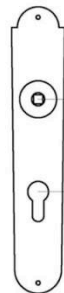

Yale - Euro Cylinder

Italia	85 mm.
Germany	92/72 mm.
Switzerland	78 mm.
Austria	88 mm.
France	70 mm.
Russia	85 mm.
Greece	85 mm.
UK-Ireland	57 mm.



WC

Italia	70/90 mm.
Germany	72 mm.
Switzerland	78 mm.
Austria	90 mm.
France	70 mm.
Russia	70/90 mm.
UK-Ireland	57 mm.

APERTURA PORTA DESTRA/SINISTRA - LEFT/RIGHT HAND

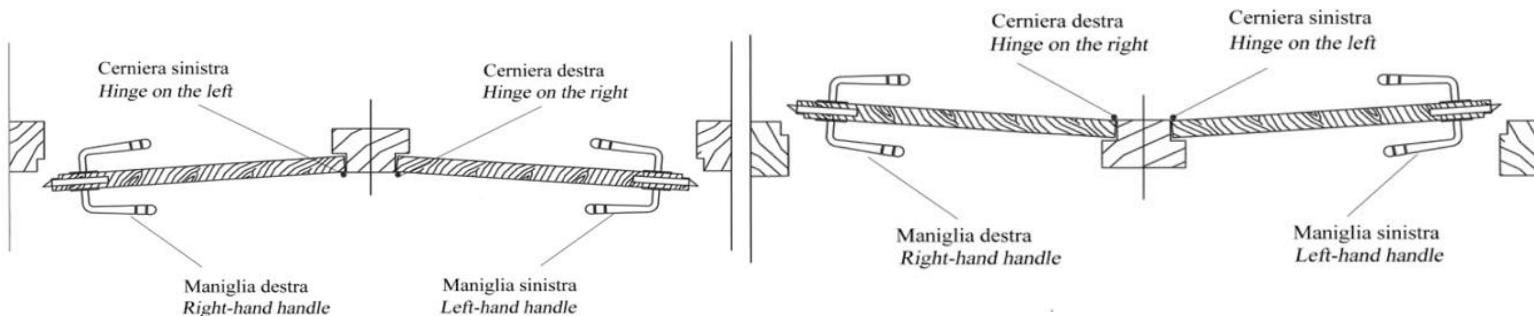



Condizioni di vendita:

- 1) La nostra Società si riserva di accettare o rifiutare qualsiasi ordinazione, anche se assunta a mezzo dei nostri agenti e rappresentanti.
- 2) La nostra Società si riserva il diritto di apportare, senza preavviso, modifiche alle caratteristiche degli articoli illustrati e descritti in catalogo, quando ciò si rende necessario per impreviste esigenze costruttive, o per migliorare la qualità degli articoli stessi.
- 3) La merce viaggia a rischio e pericolo del Committente. Non si assume alcuna responsabilità per furti, manomissioni, avarie, che si dovessero verificare durante il trasporto.
- 4) Il trasporto sia a mezzo corriere o servizio postale è sempre a carico dell' Acquirente.
- 5) La nostra Società accetta eventuali reclami unicamente se fatti entro 8 giorni dal ricevimento della merce.
- 6) Eventuali resi di merce devono essere effettuati esclusivamente dopo nostra autorizzazione con le modalità che Vi saranno comunicate al momento della richiesta del reso, comunque sempre franco di ogni spesa ai nostri magazzini.
- 7) I pagamenti devono essere effettuati presso il domicilio della nostra Società: 23868 Valmadrera (Lecco) - Via G. Verdi, 10 - oppure sul nostro conto bancario Deutsche Bank s.p.a. filiale Valmadrera, c/c 000000018400 cod. ABI 03104 - cod. CAB 51810 - C.I.N. "D".
- cod IBAN IT31D0310451810000000018400
- 8) Il mancato pagamento anche parziale ci autorizza a sospendere ulteriori invii di merce.
- 9) Per il ritardo sul pagamento convenuto all'ordinazione saranno conteggiati gli interessi bancari.
- 10) Per ogni controversia l'Acquirente riconosce unico Foro competente in via esclusiva quello Giudiziario di Lecco.

Galbusera Giancarlo & Giorgio s.n.c.



Terms and conditions of sale:

- 1) Galbusera reserves the right to accept or to refuse any order even if received through their agents or representatives.
- 2) Galbusera reserves the right to modify characteristics of the items shown and described in the catalogue, without notice, if this is required for unexpected construction requirements or to improve quality of items themselves.
- 3) Goods travel at Customer's risk and peril. No responsibility will be taken for any theft, tampering or damage during transit.
- 4) Transport by carrier or by post is the responsibility of the Customer.
- 5) All claims must be reported within 8 days from receipt of the shipment.
- 6) Returns of goods are accepted when authorized by Galbusera according to the conditions that will be notified upon the request of return, in any case ex our warehouse.
- 7) Payment: the balance due will be paid to our company: 23868 Valmadrera (Lecco) - Via G. Verdi, 10 - or at the Deutsche Bank s.p.a., branch of Valmadrera, c/c 000000018400 - I.B.A.N.: IT31D0310451810000000018400 - SWIFT: DEUTITM1028
- 8) If payment - even partial - is not received, Galbusera will be authorized to stop further shipments of goods.
- 9) If payment is not received during the time agreed upon, the payment will be subject to bank interests.
- 10) Any dispute relating to or however in connection with the contracts governed by these general conditions shall be settled by the Court of Lecco/Italy as the exclusive competent Jurisdiction.

Galbusera Giancarlo & Giorgio s.n.c.

Galbusera

**GALBUSERA GIANCARLO & GIORGIO SNC
VIA G. VERDI 10
23868 VALMADRERA (LC) ITALIA
T: + 39 0341 58.12.84
F: + 39 0341 20.10.68
E: MAIL@GALBUSERAGG.IT
W: WWW.GALBUSERAGG.IT
WWW.ANTIKBESCHLAEGE.BIZ**

Rivenditore autorizzato / Official dealer: