

TECTUS®



 **SIMONSWERK**
TECTUS®

The completely concealed
hinge system

INDEX

TE 210 3D	up to 40 kg	4
TE 310 3D	up to 60 kg	5
TE 510 3D	up to 100 kg	6
TE 525 3D	up to 100 kg	7
TE 630 3D	up to 200 kg	8
Cable set TECTUS	Accessories	9
Fixing FZ/1	Casing frame	10
Fixing SZ	Steel frame	11
Assembly		12
Adjustment		13
Calculation formulas		14



It's still design, even if there's nothing to be seen ...

»TECTUS« – This latin word for »concealed« signifies SIMONSWERK's completely hidden hinge system.

Perfection in interior decoration, limitation to the essential, always having an eye for the details – these standards are pursued by demanding manufacturers and planners and especially in applications, where, in addition to the high performance features of the hinge system, the design aspect plays a more and more important role in interior design. The hinge system TECTUS makes it possible for the first time to achieve modern, uninterrupted flush-faced surfaces also on the hinge side creating a visually harmonic overall impression.

This was the start for SIMONSWERK to enlarge the TECTUS hinge system to a complete product range, meeting the high demands of un-rebated premium choice interior doors, high performance and heavy-duty doors with casing, block, steel or aluminium frames. A scope of load capacities of 40 kg, 60 kg, 100 kg up to 200 kg allows the specific use of the hinge system. Further interesting solutions offer the optional available concealed cable conduit and a version made of solid stainless steel for the use in climatically demanding environments. Other demands towards the quality and functionality, which are nearly taken for granted, are fulfilled by three-dimensional adjustability, maintenance-free slide bearings, and by efficient assembly.

The multiple design-award winner TECTUS stands for innovative precision in straight interior design.

SIMONSWERK
TECTUS®

TE 210 3D

for unrebated and rebated, flush-faced quality doors

Hinge up to 40 kg

Technical Data

Load capacity	40,0 kg
Length (leaf/frame)	140,0/140,0 mm
Width (leaf/frame)	18,0/21,0 mm
Diameter of cutter	16,0 mm

Descriptive text

SIMONSWERK hinge TECTUS TE 210 3D. Completely concealed for unrebated and rebated, flush-faced quality doors with timber, steel and aluminium frames. CE certified, load capacity 40 kg, opening angle up to 180°, overall length 140 mm, right hand and left hand applicable, maintenance-free slide bearings, three-dimensionally adjustable: Side +/- 3 mm, height +/- 2,5 mm, depth +/- 1,5 mm. Finishes...

Combination

Fixing	Block frame	Direct screwing
	Casing frame	TE 210 3D FZ/1
	Steel frame	TE 210 3D SZ
	Aluminium frame	according to specifications of the frame manufacturer

See pages 10 - 11

To be fitted with

Jig	Universal milling frame Drilling jig TE 210 3D
Template	Frame: No. 5 250663 6 Leaf: No. 5 250664 6

Finishes

polished brass, polished nickelled, F1-coloured, F2-coloured, stainless steel effect, powder-coated

Note

Reduced risk of injury due to a very small gap between door leaf and frame.

Quality Marks

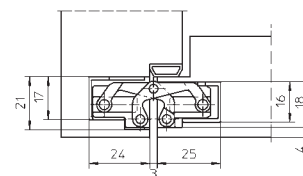
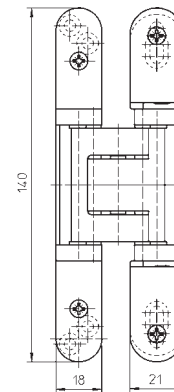

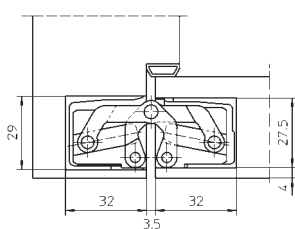
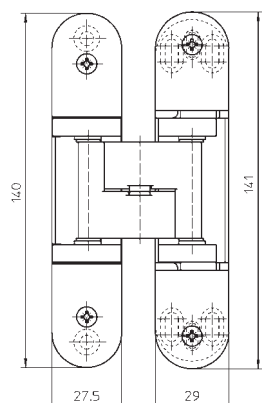

TE 310 3D

for unrebated premium choice doors

Hinge

up to 60 kg

Technical Data

Load capacity	60,0 kg
Length (leaf/frame)	140,0/141,0 mm
Width (leaf/frame)	27,5/29,0 mm
Diameter of cutter	24,0 mm

Descriptive text

SIMONSWERK hinge TECTUS TE 310 3D. Completely concealed for unrebated doors with timber, steel and aluminium frames. CE certified, load capacity 60 kg, opening angle up to 180°, overall length 140/141 mm, right hand and left hand applicable, maintenance-free slide bearings, three-dimensionally adjustable: Side +/- 3 mm, height +/- 3 mm, depth +/- 1 mm. Finishes...

Combination

Fixing	Block frame	Direct screwing
	Casing frame	TE 310 3D FZ/1
	Steel frame	TE 310 3D SZ
	Aluminium frame	according to specifications of the frame manufacturer

See pages 10 - 11

To be fitted with

Jig	Universal milling frame Drilling jig TE 310 3D
Template	Frame: No. 5 250371 6 Leaf: No. 5 250370 6

Finishes

polished brass, polished nickelled, F1-coloured, F2-coloured, stainless steel effect, powder-coated

Note

Reduced risk of injury due to a very small gap between door leaf and frame.

Quality Marks



SIMONSWERK
TECTUS®

TE 510 3D

for unrebated high performance doors

Hinge up to 100 kg

Technical Data

Load capacity	100,0 kg
Length (leaf/frame)	180,0/180,0 mm
Width (leaf/frame)	30,0/32,0 mm
Diameter of cutter	24,0 mm

Descriptive text

SIMONSWERK hinge TECTUS TE 510 3D. Completely concealed for unrebated doors with timber, steel and aluminium frames. CE and UL certified, load capacity 100 kg, opening angle up to 180°, overall length 180 mm, right hand and left hand applicable, maintenance-free slide bearings, three-dimensionally adjustable: Side +/- 3 mm, height +/- 3 mm, depth +/- 1 mm. Finishes...

Combination

Fixing	Block frame	Direct screwing
	Casing frame	TE 510 3D FZ/1
	Steel frame	TE 510 3D SZ
	Aluminium frame	according to specifications of the frame manufacturer
Accessories	Cable set	TE 510 3D MK
See pages 9 - 11		

To be fitted with

Jig	Universal milling frame Drilling jig TE 510 3D
Template	Frame: No. 5 250374 6 Leaf: No. 5 250600 6

Finishes

polished brassed, polished nickelled, F1-coloured, F2-coloured, stainless steel effect, powder-coated

Note

Reduced risk of injury due to a very small gap between door leaf and frame.

Functional Areas

Fire resistance, smoke resistance, soundproof, burglar resistance

Quality Marks

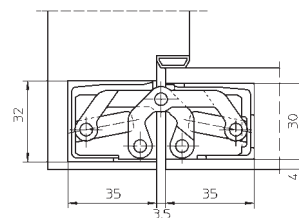
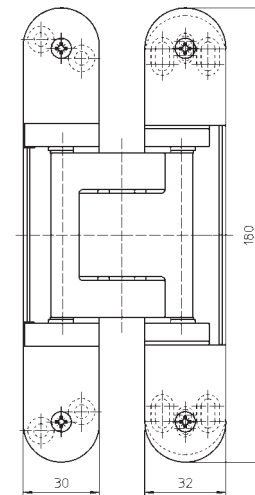



NEW

TE 525 3D

made of solid stainless steel for unrebated high performance doors

Hinge		up to 100 kg
--------------	--	---------------------

Technical Data

Load capacity	100,0 kg
Length (leaf/frame)	155,0/155,0 mm
Width (leaf/frame)	26,0/26,0 mm
Diameter of cutter	24,0 mm

Descriptive text

SIMONSWERK hinge TECTUS TE 525 3D made of solid stainless steel. Completely concealed for unrebated doors with timber, steel and aluminium frames. UL certified, load capacity 100 kg, opening angle up to 180°, overall length 155 mm, right hand and left hand applicable, maintenance-free slide bearings, three-dimensionally adjustable: Side +/- 3 mm, height +/- 3 mm, depth +/- 1 mm. Finishes...

Combination

Fixing	Block frame	Direct screwing
	Casing frame	TE 525 3D FZ/1
	Steel frame	TE 525 3D SZ
	Aluminium frame	according to specifications of the frame manufacturer
Accessories	Cable set	TE 525 3D MK

See pages 9 - 11

To be fitted with

Jig	Universal milling frame
	Drilling jig TE 525 3D
Template	Frame: No. 5 250547 6
	Leaf: No. 5 250547 6

Finishes

Satin brushed stainless steel

Note

Reduced risk of injury due to a very small gap between door leaf and frame.

Functional Areas

Fire resistance, smoke resistance, soundproof, burglar resistance

Quality Marks

169840

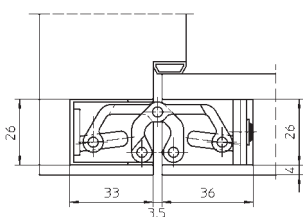
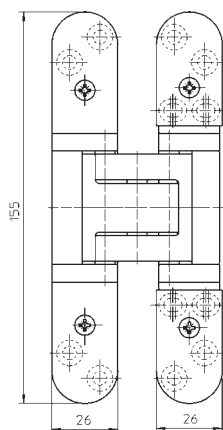

SIMONSWERK
TECTUS®

TE 630 3D

for unrebated heavy-duty doors

Hinge up to 200 kg

Technical Data

Load capacity	200,0 kg
Length (leaf/frame)	240,0/240,0 mm
Width (leaf/frame)	28,0/32,0 mm
Diameter of cutter	24,0 mm

Descriptive text

SIMONSWERK hinge TECTUS TE 630 3D. Completely concealed for unrebated doors with timber, steel and aluminium frames. Load capacity 100 kg, opening angle up to 180°, overall length 180 mm, right hand and left hand applicable, maintenance-free slide bearings, three-dimensionally adjustable: Side +/- 3 mm, height +/- 3 mm, depth +/- 1 mm. Finishes...

Combination

Fixing	Block frame	Direct screwing
	Casing frame	TE 630 3D FZ/1
	Steel frame	TE 630 3D SZ
	Aluminium frame	according to specifications of the frame manufacturer
Accessories	Cable set	TE 630 3D MK

See pages 9 - 11

To be fitted with

Jig	Universal milling frame
	Drilling jig TE 630 3D
Template	Frame: No. 5 250659 5
	No. 5 250660 5
	Leaf: No. 5 250661 5
	No. 5 250662 5

Finishes

polished brass, polished nickelled, F1-coloured, F2-coloured, stainless steel effect, powder-coated

Note

Reduced risk of injury due to a very small gap between door leaf and frame.

Functional Areas

Fire resistance, smoke resistance, soundproof, burglar resistance

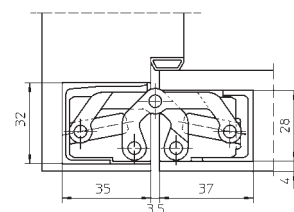
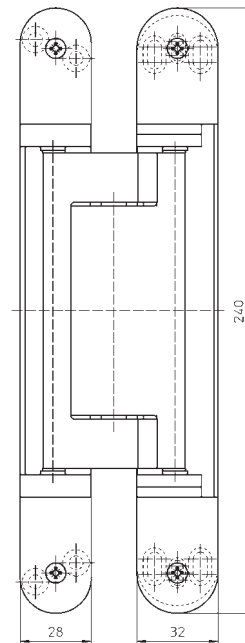

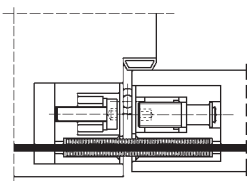
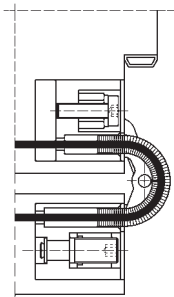
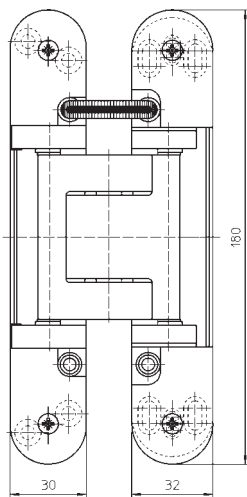

Cable set TECTUS

for concealed power line for TE 510 3D, TE 525 3D and TE 630 3D

Accessories

Technical Data

No. of wires	4 Stück
Wire cross section	0,25 mm ²
Max. voltage	48 V
Max. current	4 A

Descriptive text

SIMONSWERK cable set TECTUS TE ... 3D MK for concealed power line / cable conduit for SIMONSWERK hinge TECTUS TE ... 3D. Includes 5 m cable with cable plug for door leaf, 3 m cable with cable socket for frame, 1 tension spring, 2 compression springs (return springs), strain relief clamps and cable ties as well as cover plates for door leaf and frame section. Finishes...

Combination

Hinge	TE 510 3D
	TE 525 3D
	TE 630 3D

Finishes

F1-coloured, F2-coloured, stainless steel effect

Note

Please specify the exact hinge and Finishes in your order.

Fixing plate TECTUS series

for unrebated quality and high performance doors with casing frames

Fixing	Casing frame
--------	--------------

Descriptive text

SIMONSWERK fixing plate TECTUS TE ... 3D FZ/1 for casing frames with hinge TECTUS TE ... 3D for unrebated doors. Finishes...

Combination

Hinge	
	TE 210 3D
	TE 310 3D
	TE 510 3D
	TE 525 3D
	TE 630 3D

Finishes

galvanised

Note

Spacers for casing strengths 22-28 mm are included.
Please specify the exact hinge in your order.



TE 510 3D FZ/1

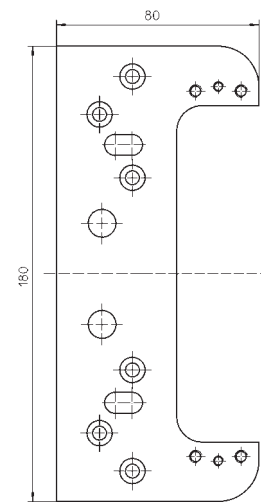

TE 510 3D FZ/1

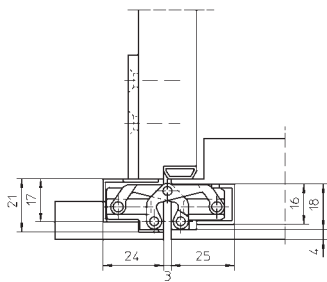

TE 210 3D FZ/1

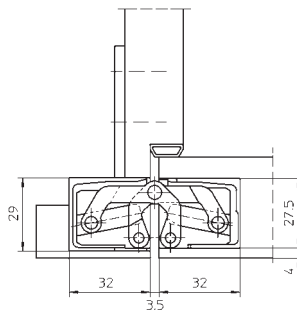

TE 310 3D FZ/1

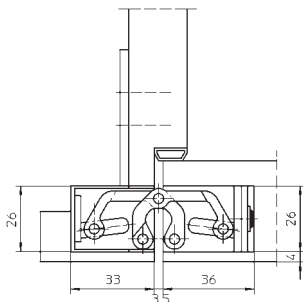

TE 525 3D FZ/1

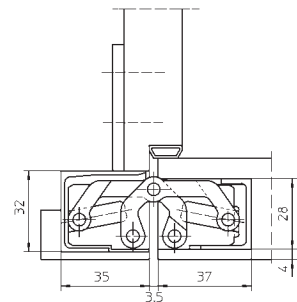

TE 630 3D FZ/1

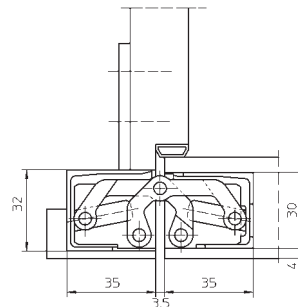

TE 510 3D FZ/1



TE 510 3D SZ

Receiver TECTUS series

for unrebated quality and high performance doors with steel frames

Fixing		Steel frame
---------------	--	--------------------

Descriptive text

SIMONSWERK receiver TECTUS TE ... 3D SZ for steel frames with hinge TECTUS TE ... 3D for unrebated doors. Finishes...

Combination

Hinge	TE 210 3D
	TE 310 3D
	TE 510 3D
	TE 525 3D
	TE 630 3D

Finishes

galvanised, untreated/raw Stainless steel

Note

Please specify the exact hinge and Finishes in your order.

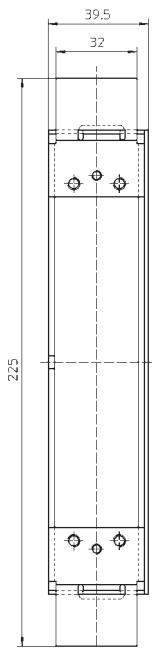

TE 510 3D SZ

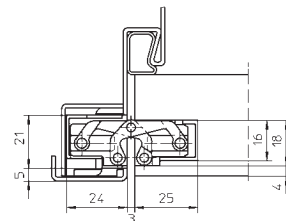

TE 210 3D SZ

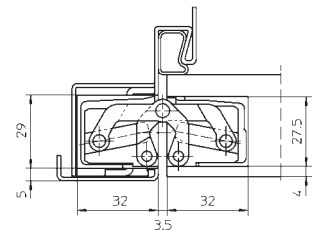

TE 310 3D SZ

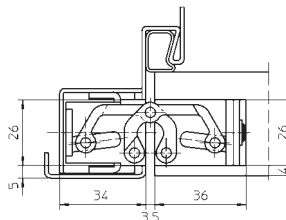

TE 525 3D SZ

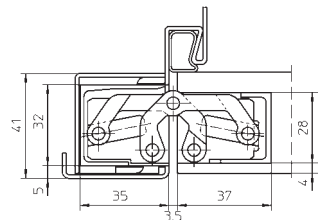

TE 630 3D SZ

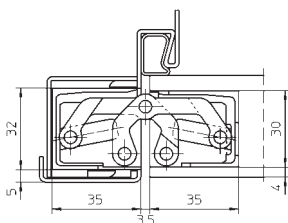

TE 510 3D SZ

ASSEMBLY

TECTUS series**SASH**

Fix sash part with woodscrews.

FRAME

Block frame

Drill the screw holes by using drilling jig TE ... 3D and drill bit \varnothing 3 mm.

Affix frame part by using enclosed wood screws.

Casing frame

Affix the fixing plate behind the casing, affix frame part by using enclosed screws M 5.

Steel frame

Affix frame part of the hinge with the prepared receiver by using the enclosed screws M 5.

Fix cover plates onto sash part with the enclosed screws.

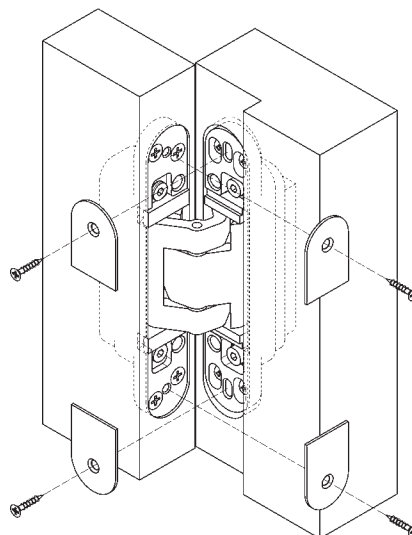
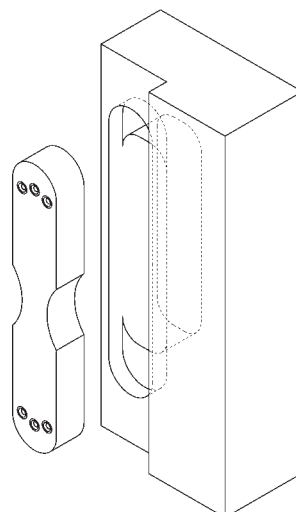
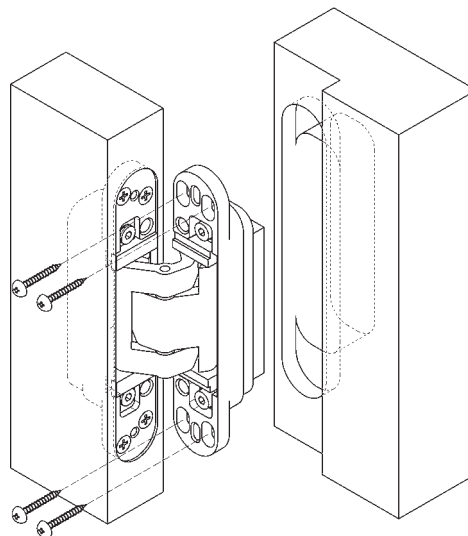

ADJUSTMENT

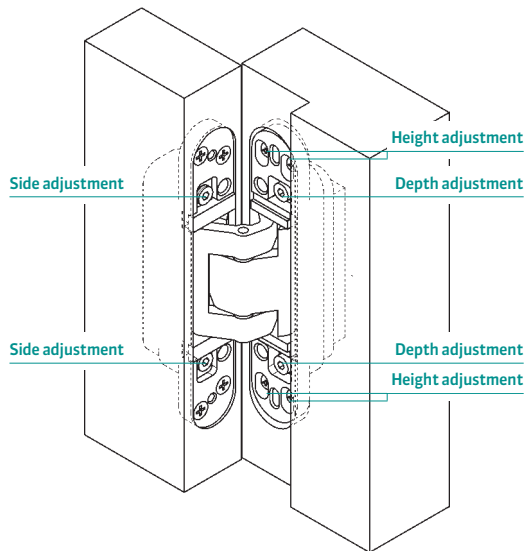
**TECTUS series****Three-dimensionally, continuously adjustable**

Side	+/- 3,0 mm
Height	+/- 3,0 mm
Depth	+/- 1,0 mm

Side adjustment

- Adjust the adjusting spindle using Allen key SW4.
- Twist left - towards hinge (max. 3 mm)
- Twist right - towards lock (max. 3 mm)

Height adjustment

- Wedge the door
- Slightly loosen the fixing screws
- Put the door to the correct height
- Retighten the fixing screws

Depth adjustment

- Slightly loosen the fixing screws
- Put the door to the correct compression
- Retighten the fixing screws

CALCULATION FORMULAS

Calculation of the milling width for timber frames

TE 210 3D

Mill with cutter Ø 16 mm, collar ring Ø 30 mm and universal milling frame with cutting template No. 5 250663 6 (frame) and cutting template No. 5 250664 6 (sash).

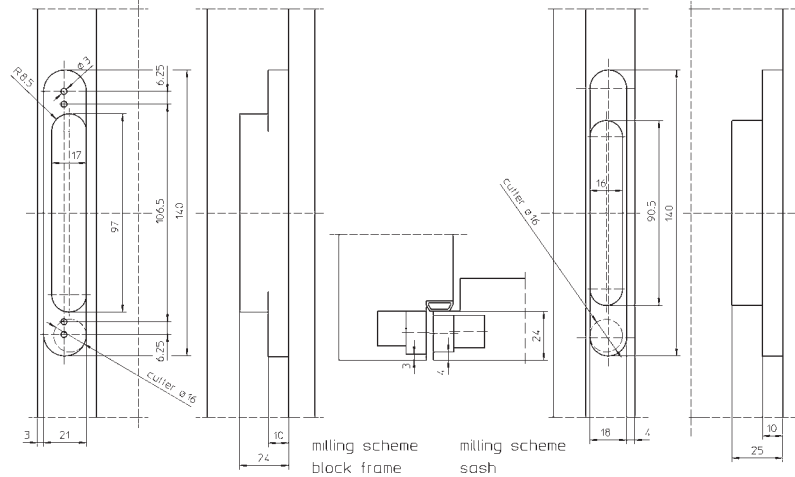

TE 310 3D

A = Depth of frame rebate up to sealing
 B = Thickness of door leaf resp. 1st sash rebate
 $A - B + 4 = \text{Measure X}$

The result has to be a measure between 4,0 mm and max. 6,5 mm. (Steel frame: X = 5,0 mm)

Mill with cutter Ø 24 mm, Collar ring Ø 30 mm and universal milling frame with cutting template No. 5 250371 6 (frame) and cutting template No. 5 250370 6 (sash).

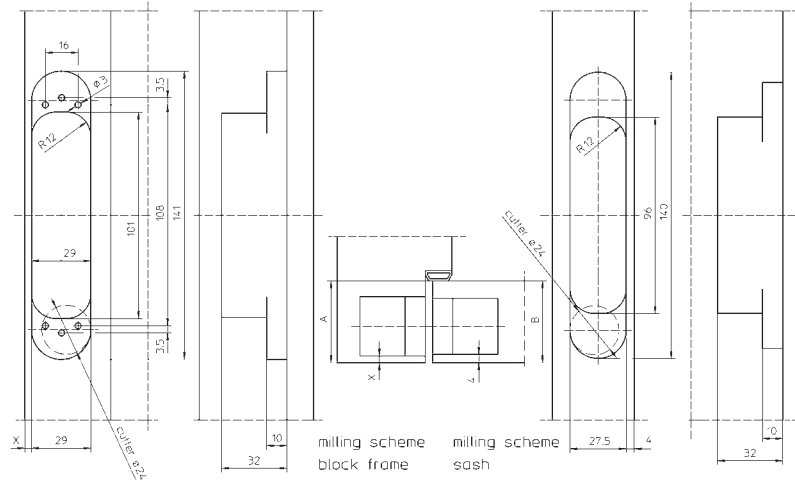

TE 510 3D

A = Depth of frame rebate up to sealing
 B = Thickness of door leaf resp. 1st sash rebate
 $A - B + 3 = \text{Measure X}$

The result has to be a measure between 3,0 mm and max. 5,0 mm. (Steel frame: X = 5,0 mm)

Mill with cutter Ø 24 mm, Collar ring Ø 30 mm and universal milling frame with cutting template No. 5 250374 6 (frame) and cutting template No. 5 250600 6 (sash).

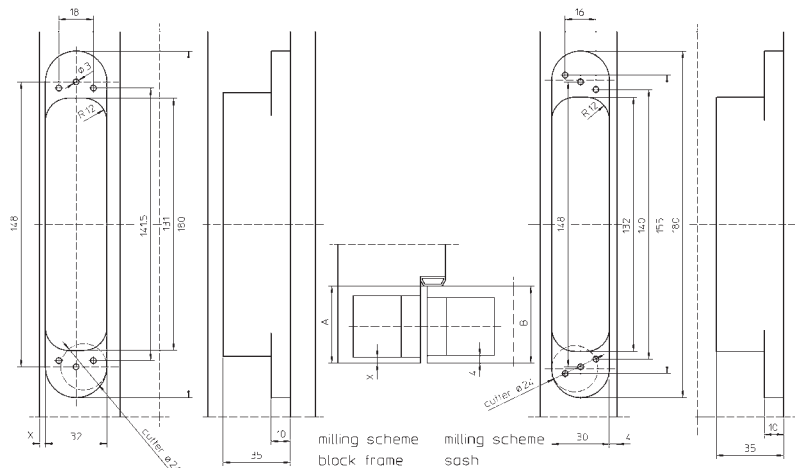

CALCULATION FORMULAS

Calculation of the milling width for timber

TE 525 3D

A = Depth of frame rebate up to sealing
 B = Thickness of door leaf resp. 1st sash rebate
 $A - B + 3 = \text{Measure X}$

The result has to be a measure between 3,0 mm and max. 5,0 mm . (Steel frame: X = 5,0 mm)

Mill with cutter Ø 24 mm, Collar ring Ø 30 mm and universal milling frame with cutting template No. 5 250374 6 (frame) and cutting template No. 5 250600 6 (sash).

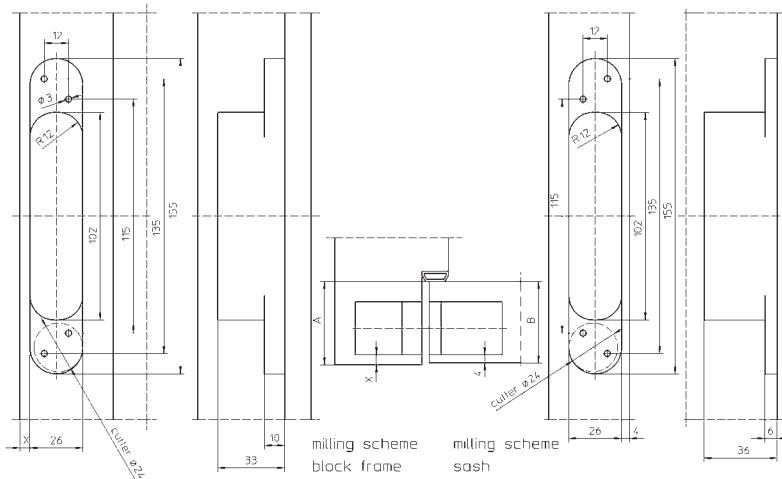

TE 630 3D

A = Depth of frame rebate up to sealing
 B = Thickness of door leaf resp. 1st sash rebate
 $A - B + 3 = \text{Measure X}$

The result has to be a measure between 3,0 mm and max. 5,0 mm . (Steel frame: X = 5,0 mm)

Mill with cutter Ø 24 mm, Collar ring Ø 30 mm and universal milling frame with cutting template No. 5 250659 5 (frame, step 1), No. 5 250660 5 (frame, step 2), No. 5 250661 5 (sash, step 1) and No. 5 250662 5 (sash, step 2).

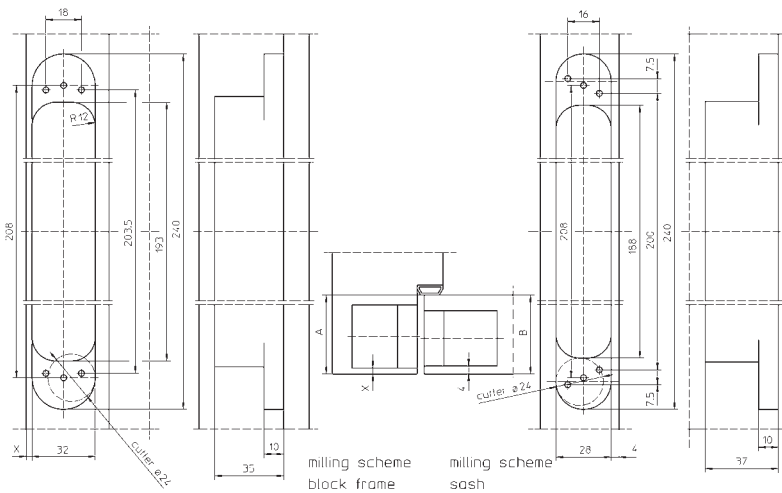

CONTAINS

 **SIMONSWERK**
TECTUS®

TE 210 3D
TE 310 3D
TE 510 3D
TE 525 3D
TE 630 3D

FURTHER BRANDS MADE BY SIMONSWERK

 **SIMONSWERK**
VARIANT® VX

 **SIMONSWERK**
VARIANT® VN

 **SIMONSWERK**
VARIANT® VG

 **SIMONSWERK**
VARIANT® V

 **SIMONSWERK**
BAKA®

 **SIMONSWERK**
SIKU® 3D

 **SIMONSWERK**
ALPRO®

TECTUS®

Brochure TECTUS®

04/2008
5 800111 0 00001/2.0



SIMONSWERK GmbH

Bosfelder Weg 5
D-33378 Rheda-Wiedenbrück

www.simonswerk.com
www.bandsysteme.de